

APPROVED BY 18 MONTHS OF PUBLIC USE  
NO OTHER BATTERY IS LIKE IT



Eveready Layerbilt "B" Battery No. 486, the Heavy-Duty battery that should be specified for all loud-speaker sets. 45 volts.

The Layerbilt patented construction revealed. Each layer is an electrical cell, making automatic contact with its neighbors, and filling all available space inside the battery case.

## Practical tests have shown this to be the most economical of "B" Batteries

IN DAILY use, in the home, Eveready Layerbilt "B" Battery No. 486 has fulfilled the promises made for it in laboratory tests. More than a year's study of the performance of this battery in the hands of the public has shown that it is the most satisfactory and most economical "B" battery ever developed. All loud-speaker sets require Heavy-Duty batteries—and the Layerbilt has proved itself absolutely the best of them all.

If you are now using the smaller, Light-Duty batteries, the Eveready Layerbilts will give you twice the service though they do not cost anything like twice as much. If you are already using Heavy-Duties, the Layerbilt, the longest lasting Heavy-Duty ever built, will run your set at least 25% longer, and again you will save money. Unless Eveready Layerbilts now are

connected to your set, you spend more on "B" batteries than you should, and you can have no idea how good a "B" battery can be. The Layerbilt holds a surprise in store for you.

Eveready Layerbilt's unequalled service is due to its unique construction. All other dry cell "B" batteries are made of cylindrical cells, with many soldered connections, and a great deal of space is wasted between the cells. The Layerbilt is built up of layers of flat current-producing elements, that make connection with each other automatically, and that fill all available space inside the battery case. It is every inch a battery. In it you get more active materials than in any other battery and the Layerbilt construction makes those materials much more efficient current producers.

Those are the convincing reasons why

the Eveready Layerbilt has proved itself the longest lasting, most economical and reliable "B" battery ever built.

Just remember this about "B" batteries—Heavy-Duty batteries are more economical than the smaller Light-Duty batteries on all loud-speaker sets, and the patented exclusive Eveready Layerbilt No. 486 is the most economical of all.

Manufactured and guaranteed by  
**NATIONAL CARBON CO., INC.**  
New York San Francisco  
Canadian National Carbon Co., Limited  
Toronto, Ontario

Tuesday night is Eveready Hour Night—9 P. M., Eastern Standard Time, through the following stations:

WEAF—New York	WTAM—Cleveland
WJAR—Providence	WWJ—Detroit
WEEI—Boston	WGN—Chicago
WTAG—Worcester	WOC—Davenport
WFI—Philadelphia	wcco—Minneapolis
WGR—Buffalo	wcso—St. Paul
WCAE—Pittsburgh	KSD—St. Louis
WSAI—Cincinnati	wrc—Washington

# Put Micrometrics on that set of yours and enjoy the marvelous tuning these dials give



To really know the wonderful satisfaction of fine tuning you must equip your set with Karas Micrometric Vernier Dials. When your set is equipped with Micrometrics you will find tuning marvelously simple and completely satisfactory. These remarkable dials turn smoothly and evenly, without bumps, jolts or slipping. They operate without a particle of backlash—and none can ever develop. They separate stations that you never could separate before—do it in the twinkling of an eye—and keep on separating them as long as the set lasts! The secret of Karas Micrometric performance lies in the high gear ratio used—63 to 1—plus the watchlike precision employed in the manufacture of the Karas gear train.

## Essential for Regenerative Sets and Superheterodynes

Karas Micrometrics are a prime necessity if you wish to get the utmost from your regenerative set or superheterodyne. The LC 27, Nine in Line, Victoreen, Madison-Moore, H. F. L., or many others, yield startling surprises in stations you never heard before, when equipped with Micrometrics. For ANY type of circuit where split-second tuning is essential because of extreme selectivity, including the Equamatic, Browning - Drake, Hammarlund - Roberts, to mention only a few, these dials will give you a tuning fineness as precise as 1-1000th of an inch. No other dial can possibly do this, because no other dial is as carefully built as the Karas.

With Micrometrics the approach to the peak or resonance point is smooth and wonderfully even, and is under the most delicate control every instant. Should you pass the exact point for maximum clearness, a flick of the finger will bring the dial back to the precise position for best results.

## Micrometrics are Absolutely Free From Backlash

More than a year was spent by Karas engineers in designing a gear arrangement which approached absolute perfection for a vernier dial. Their success was marked. No friction gears—no cams—no makeshift devices—are used in Micrometrics. Just a marvelously perfect, scientifically designed gear train attached to the large vernier knob, which is of sufficient diameter to prevent tiring or cramping of the fingers even after hours of DX hunting.

Rough tuning is done on Micrometrics with the large knob—fine tuning with the vernier knob. The latter gives a smooth, velvety, liquid-like thousandth of an inch control of the condenser such as every radio fan has wished for but has never before found in any other dial.

## Test these marvelous Karas Micrometric Vernier Dials for 10 Days at Our Risk

We want every set owner to prove every statement made in this advertisement about Karas Vernier Dials without any element of risk. So we say: Go to your dealer. Order a set of Karas Micrometrics for your receiver. Slip them on the shafts of your condensers. (No holes to drill—just one small set screw to tighten.) Try Micrometrics on your set for ten days. If at the end of that time you are not more than delighted with them, and feel that they are not worth far more than the \$3.50 each you paid for them, return them to your dealer. He is authorized to refund your money without question or quibble.

If your dealer happens to be out of stock, and you are in a hurry, you can order Micrometrics direct from us by filling out and mailing the coupon below. (Good dealers in every state in the Union carry Karas Dials, or can get them for you, but during the winter months it is not always possible for every dealer to maintain adequate stocks of Karas parts for popular circuits.) If you order direct from us you need SEND NO MONEY. Just hand the postman the price of the dials plus a few cents postage, upon delivery. Remember: Our 10 Days Test—money refunded if you are not more than delighted—applies whether you order Micrometrics from your dealer or direct from us. Act today—have Micrometric tuning on your set just as quickly as possible. Hear stations you never heard before!

**KARAS ELECTRIC CO.,**  
1091 Association Bldg., Chicago, Ill.

Please send me a set of \_\_\_\_\_ Karas Micrometric 63 to 1 Ratio Vernier Dials, for which I will pay postman \$3.50 each, plus postage, upon delivery. It is understood that I am to have the privilege of returning these dials for full refund any time within 10 days if they do not prove entirely satisfactory. Type of dials I require is indicated below:  
( ) 180 degrees—200 divisions ( ) 100-0 markings.  
( ) 360 degrees—400 divisions.

Name .....  
Address .....  
City ..... State .....  
(If cash accompanies order we will ship postpaid.)

## KARAS ELECTRIC CO.

1091 Association Bldg., Chicago



# EDITORIAL

**A** GAIN this year the public is suffering from a surplus of experts and deficit of engineers in the radio industry. And again we have a shocking list of credit losses from new failures among the manufacturers.

Some day, not this year or next, but sometime, the importance of engineering will be recognized not only by the heads of the radio companies themselves, but by the banks and supply concerns who advance credit, and by the jobbers and dealers who tie up their chances of success with the companies whose equipment they sell.

Banks and manufacturers of materials and supplies understand so well the importance of engineering skill to mining companies, chemical concerns, or contractors and builders, but they have no conception of the relation of engineering to financial success in radio manufacturing.

Suppose some hair-brained inventor induced the head of a cloak and suit company to finance him in the manufacture of Rayon silk and then the inventor ran through the funds so quickly that his backer had to take over the management. Now, who would make shipments on open account, running into thousands of dollars, to such an organization?

An order for machinery and supplies would call for an immediate credit investigation, and the fact would be disclosed at once that the concern was a poor risk because, without skilled engineers thoroughly familiar with the processes involved in the successful production of Rayon, the company would soon come to financial difficulties.

Every prospectus which accompanies the proposal of new financing for a manufacturing company always features the ability of the engineering staff and the experience of its members.

In radio it seems enough to say—"Our chief engineer is a man of wide experience, having been associated with the design and manufacture of radio equipment since 1903."

If the whole story were told, it would be necessary to state that, "Our chief engineer, while employed as a druggist's clerk, built himself a crystal detector, and heard signals from Wellfleet. His friends thought he was so wonderful that he decided then and there that he was a radio engineer, and can still put up a good bluff among those who know less than he does.

"He was at one time in the employ of the Western Electric Company, and while there he copied off all the circuits and data he could find, but that stuff's all obsolete now, so he gets what dope he can from his friends who still work there."

Some day, companies doing business with radio concerns will realize that engineering skill is directly related to financial stability in radio just as much, and more, than in other industries.

When that time comes, the manufacturers will realize that their future success depends upon the acquisition of engineering brains, and we shall then have financial stability in the industry. And then manufacturers won't have to hire away laboratory assistants and their note books from Western Electric in order to get good audio transformer designs.

M. B. SLEEPER, *Editor*

# RADIO ENGINEERING

The Technical Magazine of the Radio Trade

Edited by M. B. SLEEPER

Managing Editor, HOLLIS de NEEFE

Vol. VII.

JANUARY 1927

No. 1

Seventh Year of Publication

## CONTENTS

Resistance Coupled Amplifiers.....	527
<i>By Sylvan Harris</i>	
A Selective Filter B Supply.....	528
<i>By Harold Welches</i>	
The TC on AC.....	529
<i>By John Grabar</i>	
The Man O'War Super.....	531
Testing B Eliminators.....	533
<i>By Earl Freese</i>	
The Eclipse Super.....	534
<i>By Hollis De Neefe</i>	
Additional Data on the O1-ABC Eliminator	536
Volume Under Control.....	537
<i>By Charles Golenpaul</i>	
New Cabinets and Shields.....	538
<i>By M. B. Sleeper</i>	
Striking Developments in the Radio Field.	539
<i>A Report from the Department of Commerce</i>	
Tests on Atmospherics.....	540
<i>By M. Baumler</i>	
Wired Wireless News.....	541
Engineering and Financial Stability.....	542
<i>By Dr. A. N. Goldsmith</i>	
With the Manufacturers.....	544
Radio Coordination.....	546
Directory of Equipment and Apparatus...	547
Advertisers' Index.....	558

## In the February Issue

RADIO ENGINEERING for February will present the circuit data on a Socket-Power Super-Heterodyne. This amazing receiver uses seven 201-A type tubes and one power tube, but operates without batteries of any kind. Single control is an additional feature.

## RADIO ENGINEERING

Published monthly by RADIO ENGINEERING MAGAZINE, Inc. Publication office, Lyon Block, Albany, New York. Editorial and General offices, Radio Hill, Poughkeepsie, N. Y. Printed in U. S. A. Yearly subscription \$2.00 in U. S. and Canada; ten shillings in foreign countries. Entered as second class matter at the postoffice at Albany, New York, January 9, 1925, under the act of March 3, 1879. New York advertising office, B. S. Davis, 52 Vanderbilt Ave. Chicago advertising office, E. H. Moran, 307 N. Michigan Ave.

*Radio Engineering, January, 1927*

# Supreme in MUSICAL PERFORMANCE!

Tschaikowsky, Bee thoven, Brahms — would you listen with rapture to the rendition of their master pieces by the "hungry six" corner band? You would not!

Then why distort the masterful programs of the better broadcasting stations to the "hungry six" type of reception when Thordarson transformers are available at every dealer's?

Thordarson transformers are found in the majority of quality receivers, where musical performance is the first consideration — A conclusive proof of the musical supremacy of Thordarson amplification.

## THORDARSON RADIO TRANSFORMERS

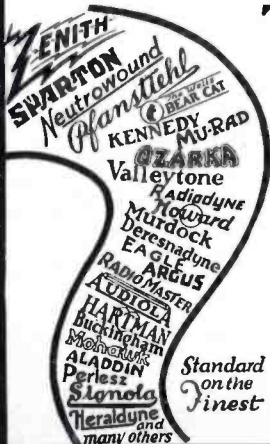

**THORDARSON ELECTRIC MANUFACTURING CO.**  
*Transformer Specialists Since 1895*  
**WORLD'S OLDEST AND LARGEST EXCLUSIVE TRANSFORMER MAKERS**  
*Turon and Kingsbury Streets — Chicago, Ill. U.S.A.*



**R-200**  
Amplifying Transformer

The transformer for the musical epicure. Has unusually faithful reproductive powers. Specified on such quality receivers as Zenith, Kennedy and Howard... **\$8.00**



**Standard**  
Amplifying Transformer

A good reproducing transformer suitable for the requirements of the average ear.

2 to 1 ratio ..... \$5.00  
 3½ to 1 ratio ..... 4.00  
 6 to 1 ratio ..... 4.50



**Autoformer**  
All Frequency  
Impedance Amplifier

Amplifies every note in the musical scale. An impedance with a step-up ratio, giving the even amplification of the impedance with the amplification increase **\$5.00** of the transformer.



**R-210**  
Power Compact

A complete foundation unit for power amplification and B-supply. Contains a power supply transformer and two chokes for power amplifier using UX-210 power tube. **\$20.00**



**R-171**  
Power Compact

Similar to the R-210 type but designed for UX-171 power tube and Raytheon rectifier. Contains buffer condensers as well as power supply transformer and **\$15.00** chokes.



**R-197**  
Power Supply  
Transformer

A Power Supply Transformer designed for B-supply using the R. C. A. UX-213 type full wave rectifying tube. Will supply up to 180 volts B. **\$7.00**



**R-196**  
30 Henry Choke

Designed either as a filter or an output choke. Completely shielded. Current carrying capacity 80 MA. Inductance 30 henries. D. C. resistance 280 ohms. **\$5.00**



**R-76**  
Speaker Coupling  
Transformer

An output transformer designed as a protective device to keep the high direct current voltage of power amplification out of the speaker unit. **\$6.00**

*Second:* In Circulation  
*First:* In Buyer Influence

**BECAUSE:** Radio set owners and set builders respond instantaneously to articles which obviously lead all other magazines in their absolute originality, the method of presentation, and the completeness of the information given.

**RADIO MECHANICS MAGAZINE**

*Edited by M. B. SLEEPER*

**RADIO HILL**

**Poughkeepsie, N. Y.**

**Chicago, 307 N. Michigan Ave.  
Phone, State, 6079**

**New York, 52 Vanderbilt Ave.  
Phone, Vanderbilt, 2274**



# SM

# Leading!



- 220 Audio Transformer ..... \$6.00
- 221 Output Transformer ..... 6.00
- 330 Power Transformer ..... 6.00
- 329 Power Transformer ..... 6.00
- 331 Unichoke ..... 6.00
- 332 Condenser Bank ..... 10.00

S-M audio transformers, output transformers, coils or power units have been selected for the following receivers—and in many form the basis of design. In this list are included the most popular recent designs.

- Infradyne (Improved model)
- Shielded Six
- Silver-Cockaday
- Best's A.C. Browning Drake
- Best's A. C. Diamond of the Air
- Radio News Batteryless Receiver
- Radio Broadcast Super
- Radio Age Super
- Radio Broadcast Local
- LC-27 Junior Power Pack
- Citizens Call Book Monotone Receiver
- Call Book Power Pack
- Callies Super
- Radio Mechanics "A", "B" and "C" Eliminator
- Radio Engineering "A", "B" and "C" Eliminator
- Radio Mechanics Man-O-War Super
- Lincoln Super
- Best's Short Wave Set
- Hush-Hush II Short Wave Set
- Popular Mechanics Super
- Christian Science Monitor 6 tube Browning-Drake
- Radio Engineering Short Wave Set
- New York Sun "B" and "C" Eliminator for Resistance Amplifier
- Chicago American Short Wave Set
- Chicago Post Power Amplifier
- Best's new Super
- Radio News Power Amplifier
- Loftin-White
- Popular Radio Town and Country Receiver
- Radio News Super

With the advent of A.C. operated, batteryless receivers, a demand for power equipment technically right has arisen almost overnight. Is it surprising, therefore, to find Gerald M. Best building all of RADIO'S A.C. operated receivers around S-M power equipment? RADIO ENGINEERING and RADIO MECHANICS, designing the first power supply to entirely replace all batteries on sets using 201-A's and power tubes, selected S-M power units as the ones best suited to this most rigorous of requirements. The RADIO NEWS batteryless receiver, a complete A.C. operated set, was, of course, built around S-M power units.

Do you realize that in this new field every important completely A.C. operated receiver power supply has been designed with S-M units as a basis—that they have led others by a wide margin?

S-M audio transformers will be found in more of this season's receiver designs than any others. Why? Because the measurements of independent testing laboratories everywhere prove them to be superior—because out of many thousands sold on a free trial basis, less than one out of every four thousand has returned to the factory for a refund—because every mail brings an unprecedented volume of enthusiastic testimonials—because the employees of the largest communication laboratories in the world buy more S-M audios than any other types.

It is the same story with minor variations for S-M condensers. S-M plug-in coils introduced in England less than a year ago, revolutionized English inductance design, and have been copied by every important English manufacturer.

It is facts like these, coupled with the S-M reputation for standing squarely behind every item produced that have accounted for the unprecedented popularity of S-M products since the first item was offered less than two and one half years ago.

It is facts like these that assure you that you cannot make a mistake when you use S-M parts, for you simply follow the lead of prominent magazine laboratories, experienced research engineers, seasoned experimenters, who have all found in S-M products the parts they themselves would have designed for their own use.

### Do you know the secret of quality reproduction?

Have you your copy of "The Secret of Quality"? It tells you simply how to get the most out of your audio amplifier—how to get real quality. It contains laboratory data never before available even to many manufacturers. It is the only authoritative treatise on all types of audio amplification written in non-technical language ever published.

It's free! Ask your dealer for a copy.

Prices 10% higher west of the Rockies.

SILVER-MARSHALL, INC.

854 West Jackson Blvd.,  
Chicago, U. S. A.

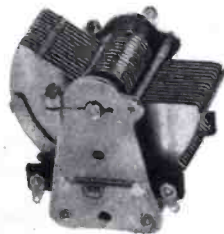

316-A and 316-B  
Variable Condensers,  
.00035, \$4.50

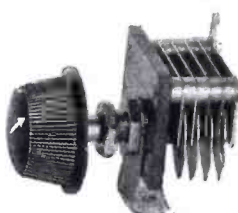

340 Balancing Con-  
denser, \$1.50



S-M Plug-in inductances, made  
in various types and ranges,  
\$2.25  
Universal Coil Socket, \$1.00



# Can't tune 'em out?

**T**RY a Micadon 601 in series with the antenna of your set, if you find it hard to "tune out" nearby stations.

The Micadon will have the same effect as "loose coupling," and the selectivity of your set will be greatly improved. Capacities from .0001 to .0005 mfd. may be used—you will find a full explanation in our 32 page booklet, "Seventeen Ways to Improve Your Set."

Micadons, because of the patented principles of low-loss insulation and protection against variation in capacity which they embody, are a vital element in the improved reception of thousands of radio sets. The tone, the efficiency, and the satisfactory operation of your set depend on the quality of the fixed condensers used.

If you want to be sure that your set will do all it was meant to do, be sure that the fixed condensers bear the name of Dubilier.

*Send 10c in stamps or coin for your copy of  
"Seventeen Ways to Improve Your Set."*

# Dubilier

**CONDENSER AND RADIO CORPORATION**

4377 Bronx Blvd., New York, N. Y.



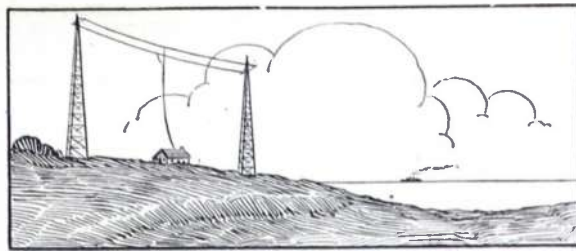

# RESISTANCE COUPLED AMPLIFIERS

*A method for determining the values of resistance and capacity in resistance coupled amplifiers—By Sylvan Harris\**

THE question of audio amplification is a very pertinent one in the radio industry today. Both the maker of complete sets and the parts manufacturer are faced by an increasing demand for good quality reproduction. Therefore the paper by Sylvan Harris, "Notes on the Design of Resistance-Capacity coupled Amplifiers," presented before the December meeting of the Institute of Radio Engineers, is very timely and to the point.

"The need for the distortionless amplifier, in the laboratory, in public address systems, and in radio transmitting and receiving apparatus is evident, and it is desirable to know to what extent the operation of an actual amplifier may differ from that of the perfect amplifier. In other words, it may be possible to design an amplifier which is 'distortionless' for practical purposes, and it is the purpose of this paper to consider the matter from this angle."

The author bases his design on the assumption that the human ear will detect and be sensitive to changes of sound intensity approximating ten percent over a wide range of frequencies. To obtain this intensity change, it can be assumed that the voltage ratio of the amplifier must change a similar amount. This voltage ratio is the proportion of the voltage output of the coupling device to the voltage input.

"Although for many purposes a variation of ten percent in the voltage ratio of an amplifier from one frequency to another may be excessive,

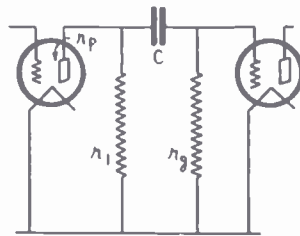

Fig. 1. Above: The elements of a resistance coupled amplifier circuit, used as a basis for the tests. Fig. 2. Below: Curves of grid leak resistance plotted against coupling capacity for amplifiers of one, two, and three stages. A frequency of 50 cycles was taken as the cut-off frequency in the calculations from which the curves were drawn.

this figure will be used for purposes of illustration. There is also to be considered the commercial phase of the problem, where a compromise is required between results and costs. The problem then is to find the required conditions in an amplifier coupling device under which the voltage ratio will not change more than 10 percent from very high audible frequencies down to an arbitrary cut-off frequency. A cut-off frequency of 50 cycles per second was used in calculating the curves given here."

Through a mathematical analysis the author determines that the maximum voltage ratio is the joint resistance of  $r_l$  and  $r_g$  in parallel, divided by the sum of this joint resistance plus  $r_p$ .

Figure 2 has been plotted to show the variation of capacity with grid leak resistance.

"In the present problem the lower limit of the voltage ratio is 90 percent of the maximum attainable voltage ratio at the output

of the amplifier. If there are two identical stages in the amplifier the value of  $k$  per stage will be the square root of 90 or 0.949; if there are three identical stages the value of  $k$  per stage will be the cube root of 90 or .966.

"A curve was plotted for the purpose of noting what effect the grid-leak resistance has on the voltage ratio. For  $r_p = 10,000$  ohms, and  $r_l = 100,000$  ohms, it was noted that little is gained in voltage ratio by making the grid-leak resistance greater than about 0.5 megohm. Applying this value to figure 2, the capacity required in a three-stage amplifier in which the output voltage will not drop

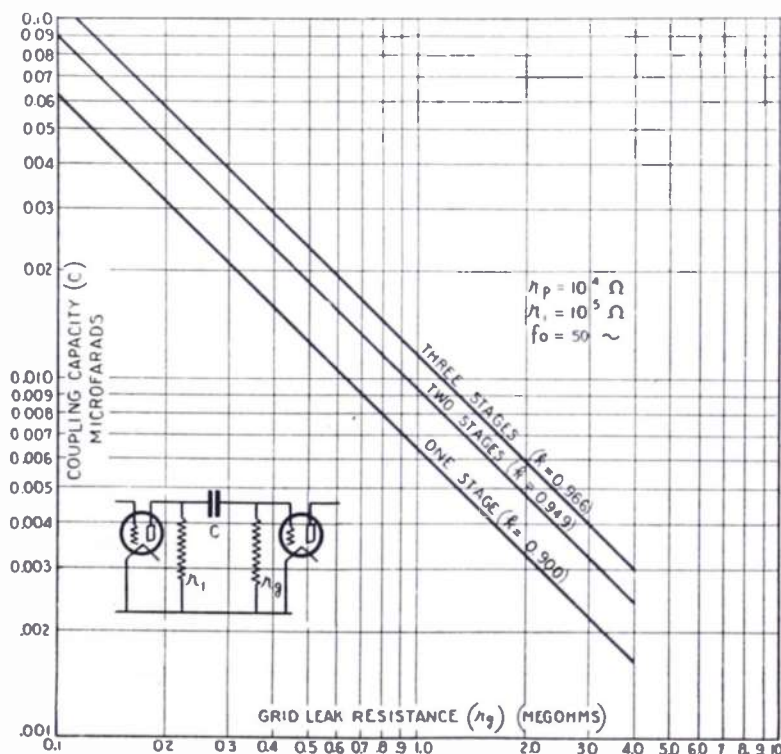

\* From a paper delivered before the I. R. E., New York, December 1, 1926



more than ten per cent from the high frequencies down to 50 cycles per second, is 0.0233 mfd.

"The choice of  $r_c$  depends not only upon the desired voltage ratio, but

must also be sufficiently low that the grid does not accumulate an excessive grid charge. This matter is apart from the subject of this paper, but is to be considered in the design of the amplifier."

cies as low as 30 cycles, thereby showing up effectively poor power supply filtration.

The obvious remedy is to employ a selective filter system rather than resort to cave-man tactics and employ extremely large, bulky and expensive choke coils and large condensers. A power supply device employing such a filter system is described herewith, which incorporates not only an apparently radically new idea to power supply manufacturers in the form of the selective filter, but, in the realization of the actual filter, incorporates another idea new even to engineers who have worked upon filter designs for years. A brief description may be of interest.

# A B Power Supply Set Featuring a Selective Filter

By Harold Welches

**S**ELLECTIVITY is a vitally important factor in a power supply device exactly as it is in a radio receiver; and as the average quality of audio frequency reproduction improves, the importance of power supply device selectivity becomes steadily greater.

As the idea of selectivity in connection with power supply devices is probably a new one to the majority of radio men, it might be well to explain the operation of the more conventional types of supply circuits in order that its significance may be appreciated. The average B power supply has a step-up transformer to step-up the 110 volts to a value which will operate the radio receiver after the losses of the filter circuit and rectifier have been allowed for. Connected to this power transformer is a single or double-wave rectifier. This rectifier changes the 60-cycle alternating current into a pulsating direct current which is then fed into the filter section. It is the filter circuit with which we are essentially concerned. The purpose of the filter is to eliminate all hum from the rectified power. After the filter system comes a combination of resistances and condensers to permit of adjustment of the output of the power supply to the required voltages for the different receivers.

The vital part of any eliminator system is the filter circuit. For there are a large number of satisfactory power transformers, rectifiers, and voltage regulator systems available upon the market.

The filter system operates much as a reservoir in a city water main

might, in that it accepts energy supplied to it periodically and stores it over the periods when none is supplied and as a result allows a continuous even flow of energy to be drawn from it. This action occurs electrically by virtue of the inductance and capacity which comprise the filter system. The conventional filter used in amateur transmitting work where the hum of the supply line need be reduced to only a comparatively low value is the so-called "brute-force" type.

The problem affecting such a filter is to suppress the very strong 120-cycle hum present in the power delivered by the rectifier. All rectifiers function as frequency doublers, hence the fundamental hum delivered by the rectifier is double that of the original supply line. In addition to this 120 cycle fundamental, as it is called, there are present harmonics (multiples of this frequency) such as 240, 360, 480 cycles, etc. The energy contained in these harmonics is very much less—only a few per cent—of that contained in the fundamental hum. Obviously, a brute-force filter, in order to be effective, must be sufficiently large to eliminate completely the 120 cycle hum, and if it is this large it will be more than ample to eliminate the harmonics. Such a filter is very difficult of construction, for extremely large inductances and condensers are required. This latter statement is not true in the case of poor receivers with poor low note audio amplifiers, but it is painfully true of many of this season's receivers where the audio amplifiers will respond most excellently to frequen-

In the schematic circuit shown herewith, at the right of the diagram appears a power transformer which is connected to a 110-volt, 60-cycle lighting circuit. Connected to this transformer is the rectifier device—in the case in question, a Rectron or Cunningham double-wave rectifier.

Just to the left of the rectifier is the filter system which is under consideration. It consists of two 2 mfd. condensers, a 4 mfd. condenser, and a double-winding iron core choke coil. The left-hand winding of this choke coil is very large—in the neighborhood of 60 henries—and in conjunction with the condensers, provides a brute-force filter adequate in itself to eliminate all hum from the supply set if it is used with a poor receiver. This filter system is very similar to that used in many standard eliminators. The right hand winding of the choke coil is of much smaller inductance and is connected in opposition to the 60-henry inductance. These coils being wound in opposition, bring into play a principle never heretofore used in filter design—that the resulting mutual inductance will be practically resistanceless. This resulting mutual inductance in connection with the lower central 2 mfd. condenser forms a very low resistance circuit resonant at 120 cycles, and effectively eliminates the powerful hum delivered by the rectifying device. The entire effectiveness of this system is dependent upon the use of opposed coils of exactly the right values, for the resistance of an ordinary inductance, used to form one leg of the resonant circuit, would be so high as

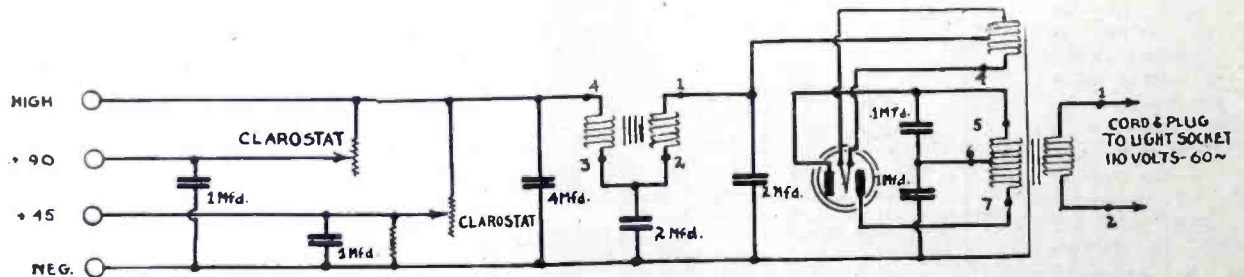

Schematic of the B power supply set. The selective action is obtained through a special choke coil of two windings, resonant at 120 cycles.

to preclude adequate filtration. The designer, Kendall Clough, director of the Research Laboratories of Chicago, has solved the problem very nicely by the use of opposed inductances, creating a practically resistanceless mutual inductance, which is used in the selective circuit.

So far the elimination of only the powerful fundamental hum has been considered. The brute-force action of the 60-henry inductance together with the 10 microfarads of condenser is more than ample to eliminate the harmonics, which contain very little energy. As a matter of fact, this filter system is as effective as many of those employed in many present-day power devices for elimination of not only the harmonics but the fundamental 120-cycle hum as well.

At the extreme left of the diagram will be seen the voltage regulator circuit consisting of one fixed and two adjustable resistances and two bypass condensers.

The schematic diagram of the complete eliminator shows how it can be connected using standard parts available upon the market. A list of the necessary parts is given below:

- 1 S-M type 329 power transformer.
- 1 S-M type 331 Unichoke.
- 1 S-M type 332 Condenser Bank.
- or
- 2 2 mfd. condensers.
- 1 4 mfd. condenser.
- 2 1 mfd. condensers.
- 2 1/10 mfd. condensers.
- 1 10,000 ohm resistance capable of dissipating 5 watts.
- 2 Clarostats.
- 4 Binding posts.
- 1 Sub-base.

One caution is in order. It is vitally important that the condensers procured for this supply set be guaranteed for an operating voltage of not less than 300 volts.

In operation there are certain cautions to be observed. The supply set may be turned on and off by means of the separable attachment plug supplied with the power transformer. It should never be turned on before the receiver is turned on and it should always be turned off before the receiver is turned off, for otherwise the bypass condensers in the receiver may be damaged due to surge voltages. This is true of any type of power supply.

The output voltage of the supply set is 270 volts at 10 milliamperes and falls off gradually to 180 volts at 60 milliamperes. This power output is ample for the operation of ordinary receivers which draw in the neighborhood of .30 to 40 milliamperes, and under such conditions it will very nicely supply an entire receiver with a UX171 power tube. In fact, by the use of a 1,200-ohm Yaxley potentiometer connected in series from the negative side of the supply set to the receiver, ample C voltage can be obtained for the last audio frequency amplifier such as UX112 or UX171. If this is done, the C minus lead for

the power audio stage should be connected direct to the minus post of the power supply set and the 1,200-ohm potentiometer adjusted for best quality. In connecting this potentiometer in circuit only two binding posts are used—one connected to the central arm and the other one joined to one end of the resistance sector.

Frequently in operating a power supply device, trouble from motor-boating is experienced. This can be eliminated by connecting condensers of from 4 to 15 microfarads across the B battery terminals of the receiver. In the power supply device

in question, an additional precaution to eliminate such noises, and possible hum in case the receiver (which may operate from a loop) is ungrounded, is provided in the form of an electrostatic shield contained in the power transformer. This shield terminates in connection No. 8 of the type 329 power transformer and in case any trouble is experienced, this No. 8 terminal should be disconnected from the wiring of the power supply and connected directly to a good ground. The filament circuit of a receiver with which a power supply device is used should always be grounded.

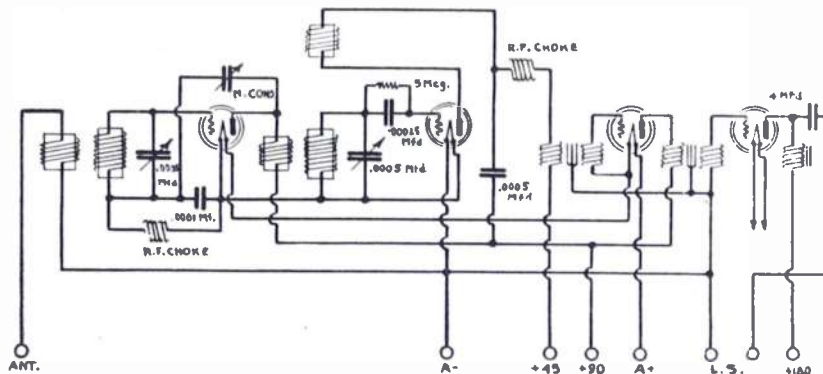

Schematic of the TC, the first receiver, using 201-A tubes, to be designed for batteryless operation.

## The TC on AC

The popular TC set, using 201-A tubes, adapted to house current operation—By John Grabar

VARIOUS methods have been presented for AC operation of receivers, and, so far, all of these have had several drawbacks. However, the receiver described here is a thoroughly practical one, and its design and construction offer no difficulties to the builder.

Of undoubted interest to the technical men was the data, in RADIO ENGINEERING for December, on the 01-ABC eliminator. This apparatus was the first practical outfit, built of standard parts, to be offered to the public as an eliminator of all batteries on 201-A circuits.

The TC\* set is the first receiver to be designed for use with the 01-ABC eliminator. Needless to say, the complete outfit, consisting of receiver and power plant, operates splendidly. An analysis of the schematic will be of interest, for, although series filament wiring presents no practical difficulties, many are unfamiliar with its adaptation to radio receivers.

The minus A line goes first to the detector, then to the RF tube, and from there to the first AF amplifier. At this point, the plus A is connected to the other filament terminal of the first audio tube, which completes the filament circuit. In all cases here, the

grid return of each tube is made direct to the minus F of the tube. However, if a 201-A is used for the detector, instead of a 200-A, the grid return of the detector coil secondary should be made to the plus F of the detector tube socket.

As this circuit is wired, 90 volts are used on the RF and first AF amplifiers. With this voltage used, it is inadvisable to employ a negative bias on the first audio tube. However, the 135 volt tap on the 01-ABC eliminator can be applied to the first audio, if desired. In this case, the grid return of the first AF transformer would be made to the negative F of the RF tube, which would place a negative bias of 5 volts on the grid of the first audio tube, due to the drop through the RF filament.

It can be seen that series filament wiring is very simple, and, further, that it offers the utmost flexibility in the matter of grid biasing. Series wiring is much more easily done than the usual parallel method, and there is no necessity for rheostats or ballast resistances.

The circuit of the TC on AC is standard, but, to those who have not studied this set before, there are a few items which will prove interesting. The RF stage is neutralized by a method somewhat different from that usually

\* Complete Construction Article in Radio Mechanics for February.



employed. An RF choke is inserted in the grid return lead, and a .0001 mfd. fixed condenser is in parallel with this choke. At first glance, it may seem somewhat queer to use a choke to keep the RF out, and then use a condenser to let it through. However, the choke used here employs a helical type of winding and, due to its very low distributed capacity, it is so effective that a bypass condenser is necessary in order to facilitate neutralization.

The primary coil in the plate circuit of the RF tube is variable. This is an excellent feature, for it permits of optimum coupling at every wave length, and it can be varied so as to obtain any required degree of selectiv-

purchased on the open market. It is true that some AC operated receivers have made their appearance, but it is significant that most of the successful ones use 199 type tubes. Since these tubes are rather fragile, and very sensitive to overloading, the utmost care must be taken to see that the output of the power device with which they operate is not allowed to exceed a certain definite value.

Take, for instance, a super-heterodyne, or other multi-tube set, which uses 199 in series, and operates from AC through a rectifier and filter system. A little study reveals the fact that the plate current of each tube is added to the filament current of the

- 2—Samson .0005 mfd. S.L.F. condensers;
- 2—Samson No. 85 RF chokes,
- 2—Samson symphonic audio transformers;
- 1—Samson output Impedance, type O;
- 1—Samson neutralizing condenser;
- 4—Na-aid spring cushioned sockets;
- 1—Tobe 2 mfd. filter condenser;
- 1—Sangamo .00015 mfd. fixed condenser;
- 1—Sangamo .001 mfd. fixed condenser;
- 3—Silver-Marshall No. 540 mounting brackets;
- 1—Bakelite front panel, 7 x 18;
- 1—Bakelite sub panel, 3 x 17;

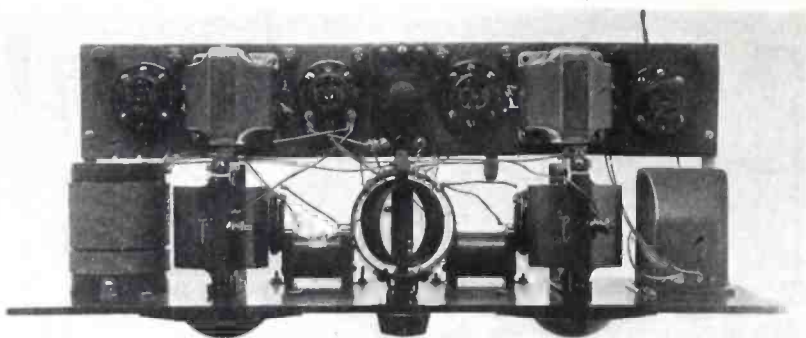

Airplane view of the TC set. Symmetrical layout, compact construction, and full AC operation are combined in this ultra-modern receiver.

ity. A variable primary permits a large number of turns to be used. Then, when longer wavelength stations are to be tuned in, the coupling can be tightened, with a considerable over-all gain in amplification.

The choke coil in the plate circuit of the detector serves two purposes. First, it assures that regeneration can be obtained over the entire waveband, and second, it keeps the RF out of the audio amplifier.

Naturally, the big feature of this TC receiver is the fact that it operates without batteries of any kind. There are no accessories used which require attention or replacement. The advantages of this system are at once apparent. There are countless thousands of prospects for such a receiver, and here is the chance for the dealers and their technical men to get together and cash in on this undeveloped field.

No part of the construction or operation of either the receiver or its power plant is at all difficult. Any one gifted with a mere fundamental knowledge of radio and electrical circuits can put the two outfits together in a short time. In fact, the construction articles in Radio Mechanics on this apparatus are presented in such a clear manner that the novice should have no trouble in assembling his own.

The cost of the eliminator is about the same as that of a storage battery, charger, and good B eliminator. The cost of parts of the receiver is considerably less than that required for a factory built set of equivalent ability and performance.

The most important thing, however, is the fact that the two cannot be duplicated in a factory assembled outfit,

tube following it. In order to avoid overloading the filaments of the succeeding tubes, it then becomes necessary to employ, across each filament resistances which will bypass the excess current. When the resistances are used, bypass condensers should be employed, to offer a low resistance path for stray RF. The result of all this is, that the assembly and wiring of such an outfit is considerably complicated, and, of course, the cost is increased as well.

No such criticisms can be uttered against such a receiver if it uses 201-A type tubes. Even in the case of a large set, the total plate current added to the last tube's filament will seldom exceed 20 to 25 mils. If we are operating the 201-As as their maximum rating of 250 milliamperes, this would only represent an overload of 10 per cent, which, for most purposes, is negligible.

The TC on AC is the logical answer to a long felt want. The receiver and power plant form an ideal combination, and will be sure in appeal to the set prospects, particularly the women, who want radio without its usual attendant fuss and muss. Of greatest importance to the dealer is the fact that he can now fill this want. Further, such a receiver is not yet made commercially, and the dealer who starts now to push these outfits, will find himself in the always enviable position of the man who starts first.

The list of parts, as used in our original laboratory model of the TC on AC, is as follows:

- 1—Samson fixed coupler;
- 1—Samson double rotor coupler;

- 8—Eby binding posts, marked as follows: Ant. B plus 45, A plus, A minus, B plus 90, B plus Amp., 2 output;
- 2—Kurz-Kasch Aristocrat Vernier Port Dials;
- 2—Kurz-Kasch rheostat knobs;
- 1—Roll Cornish "Corwico Flexibus" wire.
- 1—Pkg. Lastites for 6-32 screws.
- 2—doz. soldering lugs, tinned.
- 1—(Wireless Specialty Apparatus Co.) Faradon grid condenser—.00025 mfd. capacity;
- 1—Gridleak—2 megohms.
- 1—doz. 6-32, 1/2 inch, flat head machine screws,
- 1—doz. 6-32 1/2 inch round head machine screws;
- 2 doz. 6-32 nuts for above;
- Rosin core solder.

One fact should not be overlooked by the dealer, in connection with the TC on AC. While the design of the outfit is very simple, and its construction will present no difficulties to the technical men, its operation is none the less remarkable.

The dealer who wishes to gain for himself an enviable reputation as an authority on AC receivers, and who can see the possibilities presented by establishing his store as a headquarters for such apparatus, will do well to build one of these sets for display in his salesroom.

Nothing is so convincing, or arouses so much interest, as an actual demonstration. Hearing, as well as seeing, is believing, and the prospect is naturally in a more receptive mood for sales argument when tangible proof of the claims is before him.

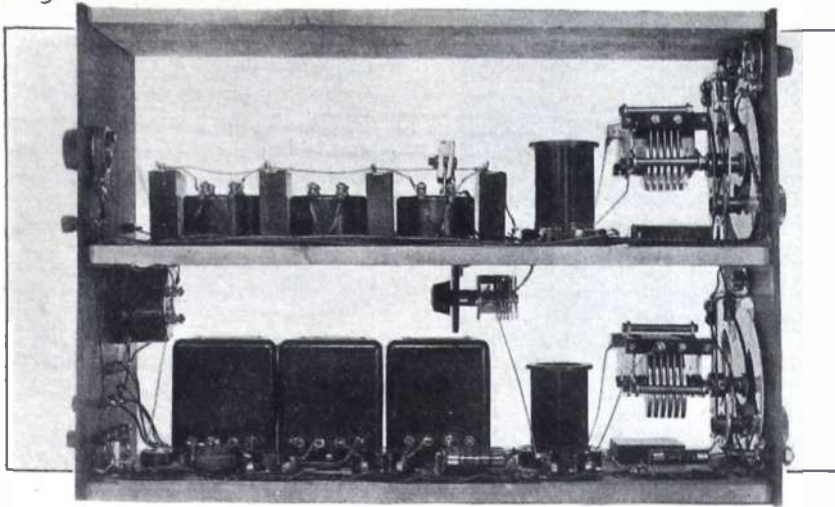

Side view of the completed Man O' War assembly. The upper condenser tunes the antenna, and the oscillator equipment is mounted directly underneath.

## The Man O' War Super-Het

*Showing a new mechanical layout to increase the efficiency of this powerful receiver*

FOR the dealer who is on the lookout for something to catch the popular fancy, we present here a new note in receiver design and construction. The idea is distinctly new, but fundamentally, it is so sound that it seems strange no one has employed it before.

Hitherto, with conventional designs, it has been very difficult to effect a close and efficient spacing and sequence of apparatus without encountering interaction between the various circuits. Further, unless a standard baseboard was used for the layout, the builder was apt to meet with difficulties of assembly and construction.

In the Man O' War super-heterodyne\* shown here as the first receiver

to use our new drendnaught design, the incoming signal follows a short and direct path from one tube to the next. For instance, the oscillator coil is so mounted that it does not feed stray energy into the other circuits. Although this is the case, the double decked design permits of a short coupling lead between the oscillator and the first detector.

A further advantage of the new system is that the cost is reduced. It is a very simple matter to hinge two side pieces to the upper shelf. Then, when these are properly finished and stained, the builder possesses a neat and serviceable cabinet, and all parts of the circuit are readily accessible for inspection or repair.

Using this method of construction, the wiring of any set is simplicity it-

self, regardless of the circuit used or the number of tubes employed. The system is applicable to every popular circuit. The middle shelf, in each case, can be considered as a baseboard, and practically all the wiring can be done on this section before it is attached to the panels. The same, of course, applies to the bottom baseboard.

It can be seen that, with each part of the circuit laid out so conveniently in this manner, less trouble will be experienced with incorrect or loose connections caused by difficult soldering in inaccessible places.

While the circuit used in the Man O' War super is not essentially new, there are several features and refinements used in its construction that will be of interest. This receiver was designed to use an antenna, rather than a loop, for several reasons. In the first place, the set is very compact, and if it is placed in some convenient place in a small apartment, there will be insufficient space available in which a loop can be turned. Further, comparative tests have disclosed the fact that a short indoor antenna is more efficient than a loop.

Another advantage is gained by the use of an antenna in the first detector circuit. Regeneration is incorporated in the first detector, for the use of this principle adds greatly to the selectivity and sensitivity of the outfit. The antenna coil used here has a fixed tickler so placed, that, normally, the tube to which it is connected would oscillate continuously. In order to control regeneration, a high resistance potentiometer is shunted across the tickler, and the center arm of this resistance is led to the primary of the filter transformer. With this arrangement, the rotor of the tuning condenser is at ground potential.

However, if a loop were used, and regeneration obtained by a small feedback condenser, which is the method usually employed, both sides of the loop condenser would be above ground potential, and troublesome body capacity might be evident.

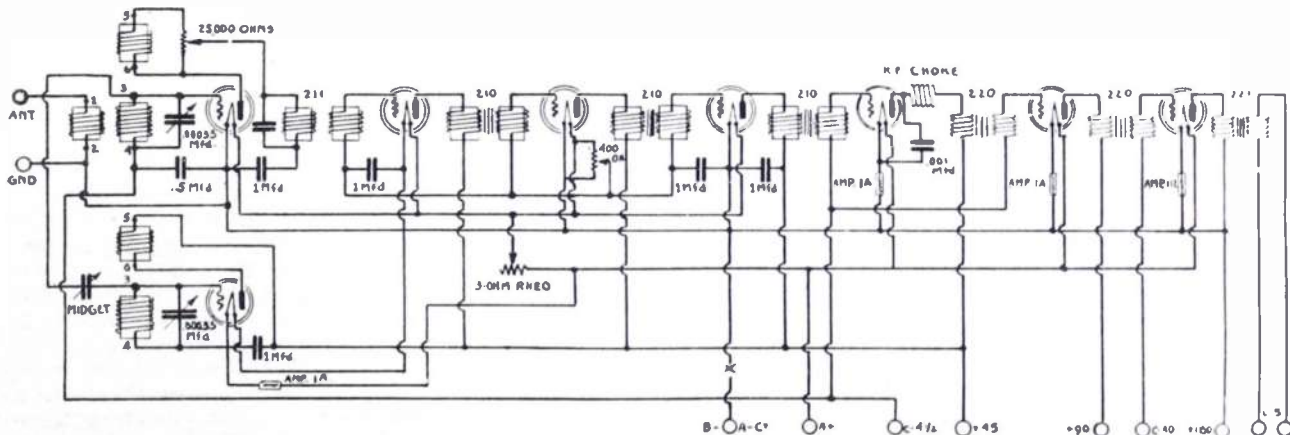

Schematic of the Man O' War Super. The oscillator and first detector are capacitatively coupled, and the method of obtaining regeneration in the first detector circuit permits the use of a grounded rotor condenser.



The oscillator is coupled to the first detector by a midget condenser, instead of by the pickup coil usually employed for this purpose. This arrangement is more convenient here because of the coils used, and it will be found that the coupling can be varied very smoothly in actual operation.

The first and second detectors rectify by means of a negative grid bias furnished by a C battery, instead of the conventional gridleak and condenser combination. This may mean a slight loss of sensitivity, but the receiver is naturally so sensitive that a slight decrease in this respect can be well afforded, in this case. Further, the C battery method of detection provides far greater handling capacity for strong signals, and affords a considerable gain in selectivity.

The choke coil effectually obviates any such possible trouble however, and its use is at once apparent in the improved quality of reproduction obtained.

For much the same reasons as set forth above, transformer coupled audio is far preferable, for super-heterodynes, to other forms of audio coupling. It is very difficult, and often impossible, to incorporate a resistance or impedance coupled audio amplifier after the second detector of this circuit. In those cases where such audio is used successfully, it will be found that the handling capacity of the amplifier is considerably less than that of the transformer coupled job.

For these reasons, it is recommended that transformer coupled audio be used in this circuit. It is advisable to ground the cases of the

2 Polymet .5 mfd. by-pass condensers;

1 Polymet .001 fixed condenser;

3 Amperites type 1A;

1 Amperite type 112;

8 General Radio UX sockets;

2 Mar-co illuminated controls;

2 Cardwell taper plate .00035 mfd. condensers;

1 Carter HI-pot, 25,000 ohms;

1 Carter Potentiometer 400 ohms;

11 Eby binding posts, marked as follows:

Ant, Gnd, A plus, A minus, B minus, C plus, B plus 45, B plus 90, B plus 180, C minus, C minus 40;

1 Electrad filament switch;

1 Electrad certified jack, open circuit;

Shown here are the separate sections of the Man O' War, before assembly. At the extreme left is the front panel, including the tuning condensers and controls. Next are the audio amplifier and oscillator.

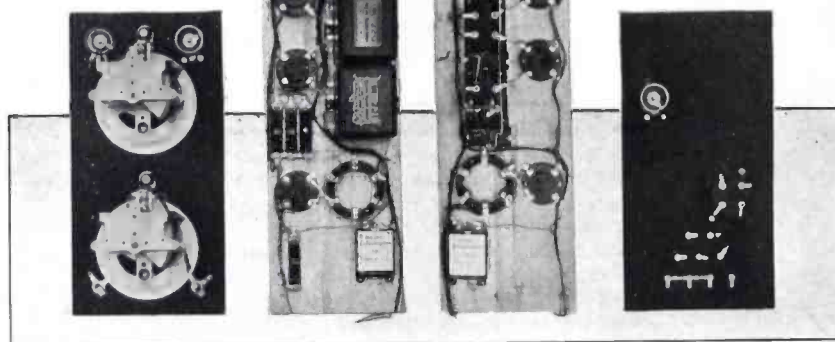

The first detector and intermediate train are on the next shelf, and the rear panel supports the rheostat, binding posts, and the I.F. transformer which couples the second detector to the intermediate stages.

The Man O' War is designed to use the 171 type power tube in the last stage of audio. No other tube, unless it were of the 210 type, could possibly handle the output of this powerful receiver. In fact, the 171 is an ideal tube to use in this set, for it can stand a greater input voltage, without the grid swinging positive, than any other tube. In addition, the volume delivered by the set is so great that the low amplification factor of the 171 is not a disadvantage.

A choke coil is used between the second detector and the audio amplifier, and of course, the usual .001 or .002 mfd. bypass condenser is connected from the plate of the detector to the minus F. This choke coil is omitted in many super designs, but its use is vitally important because of the particular conditions encountered in super-heterodyne circuits.

As is well known, the frequency used in the intermediate amplifier of a super employing iron core transformers is rather low, and ranges, ordinarily, from 30 to 60 KC. Now, under some conditions, this low frequency might have a tendency to feed into the audio amplifier, which would then result in instability of the entire receiver and, possibly, in audio oscil-

lators either directly to ground, or, in cases where that is impossible, to the minus A line. In many cases, it is also advisable to shunt the secondary of the first transformer with a fixed resistance of about .2 megohm. While this arrangement may decrease the amplification somewhat, it has a tendency to better the quality of reproduction, and stabilizes the whole audio system.

The list of parts as used in the Man O' War super-heterodyne, is as follows:

3 Silver-Marshall No. 210 long wave transformers;

1 Silver-Marshall No. 211 long wave transformer;

2 Silver-Marshall No. 220 audio transformers;

1 Silver-Marshall No. 221 output transformer;

2 Silver-Marshall No. 111-A plug-in coils;

2 Silver-Marshall No. 515 coil sockets;

1 Silver-Marshall No. 276 choke coil;

1 Hammarlund 11 plate midget condenser;

4 Polymet 1. mfd. by-pass condensers;

2 7 x 14 Bakelite or hard rubber panels;

3 1/2 x 6 x 19 1/2 baseboards — white wood;

1 pkg. Lastites for 6—32 screws;

6 doz. tinned soldering lugs;

3 doz. 1 inch. r.h. wood screws, No. 6;

3 doz. 1/2 inch. r.h. wood screws, No. 6;

2 wooden side pieces, 1/2 x 14 x 19 1/2;

1 Carter 3 Ohm rheostat;

50 Ft. Corvico Flexibus in following colors:

10 ft. yellow;

10 ft. red;

10 ft. black;

10 ft. brown;

10 ft. green.

The dealer can try some very interesting experiments with this receiver. For instance, the set can be sandwiched in some small space on a convenient shelf. Then, when the tuning controls are illuminated, and a signal is tuned in, the unique appearance of a set which produces such volume and quality of tone, is certain to cause comment, and pave the way toward more parts sales.

## Makeshift Meters

—By John H. Miller\*

A NUMBER of articles have appeared in the radio press in which it is stated that a high resistance voltmeter may be made by connecting in series a low reading milliammeter and a high resistance of the proper value. For instance,—a milliammeter, reading one milliamper full scale, used in conjunction with a .2 megohm resistance, will make a legitimate voltmeter, reading 200 volts full scale.

It is, however, very difficult to obtain on the open market a high resistance of the proper accuracy and made of the proper material for such a purpose. The average man will go to a radio store and purchase a grid leak or other high resistance which is entirely unsuitable for the work on hand.

That is, a .2 megohm grid leak rarely has a resistance of .2 megohms. Grid leaks are usually adjusted by the large manufacturers to come within 10%, and many on the market are far from this accurate. The voltage readings will be no better than the accuracy of the grid leak.

Further, every grid leak has a material temperature co-efficient, those of carbon or inked paper having a negative co-efficient, and some other types being positive. They will vary as much as ½% per degree Fahrenheit. Even though compensation be made for room temperature, the current through the grid leak will usually heat it so that its temperature is considerably above that of the room and more errors result.

It should be understood, of course, that for their purpose, grid leaks are entirely satisfactory, since a variation of 10% in the value of the grid leak or high resistance in a receiving set or resistance coupled amplifier, makes very small difference. Such an error in the reading of voltmeter is, however, a different matter.

High resistance voltmeters are expensive because their resistance is made of wire properly insulated and of the proper alloy to have a zero change of resistance with temperature. Being made of such material, they will read accurately under all ordinary conditions.

Such wire wound resistances for several hundred volts usually contain several thousand feet of wire, and are consequently expensive to make.

In view of these facts, a voltmeter made with an ordinary grid leak can rarely be relied on to better than 10%. In many cases the error will be greater.

If such a combination is used it should at least be done with a knowledge of the possible errors and not with the expectation of securing a high grade and accurate high resistance voltmeter.

\*Engineer, Jewel Elec. Inst. Co.

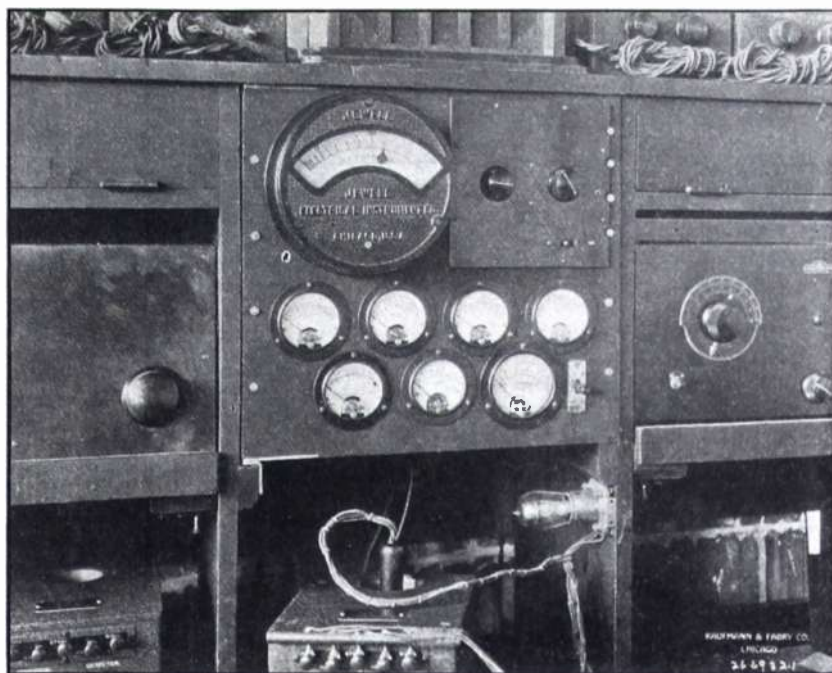

A closeup view of the All-American "B" Eliminator test board. In order to assure absolute uniformity of input from the A.C. line the big Jewell meter is kept constantly in view. Smaller meters indicate exact outputs from various taps of the eliminator while in actual operation with a receiver.

## Testing B Eliminators

*Proper testing of apparatus insures dealer protection and customer satisfaction—By Earl Freese\**

ONE of the biggest factors in bringing about stability in present day radio manufacture is the use of more intelligently designed testing equipment. Before a manufacturer can turn out a receiver, an eliminator, a reproducer, or any other assembled unit, he must not only be equipped to test out the final product but must have special apparatus for testing each individual part that goes into the construction. Perhaps one of the best examples of a product that must meet every test with exactness is a modern B eliminator or constant B supply.

After making all the necessary mechanical and electrical tests on the work benches, the completely assembled eliminator is transferred to the final test rooms, where a very comprehensive final test is given. This final test, first of all, is a reception test. The eliminator is put into operation with both a 5 and 7 tube receiver, so as to enable the test bench operator to assure himself that it is capable of operating more than one type of receiver. This test gives the operator an opportunity to test out the unit at both "high" and "low" switch settings. The "High-Low" switch is a feature, adapted by several manufacturers, to enable users to adjust the voltage output of the eliminator in proportion to the number of tubes in the set with which it is used.

A group of laboratory meters are mounted prominently on the test board, and are wired in series with the output taps of the eliminator. These meters indicate exactly what the voltage output is on each tap while in operation, both with the 5 tube and 7 tube receiver. The slightest defects in the eliminator's ability to supply rated voltages are quickly noted on this test, and imperfect eliminators are immediately rejected. The test board also provides a meter to indicate the milliamper drain of each receiver on test, as well as a continuity test for locating shorts and grounds. By actually tuning in broadcasting stations, the operator makes certain that there is no hum, and that clear undistorted tone will be provided when the eliminator is used with any receiver of reasonable quality.

The knowledge that these comprehensive and exhaustive tests are applied to each B eliminator before it is released for sale is very encouraging to radio dealers, service men and users, because it means they will be assured of purchasing and installing a first-class unit that measures exactly up to every standard, and which will bring the very best of tone and distance out of any receiver with which it is installed.

\*All American Radio Corporation.



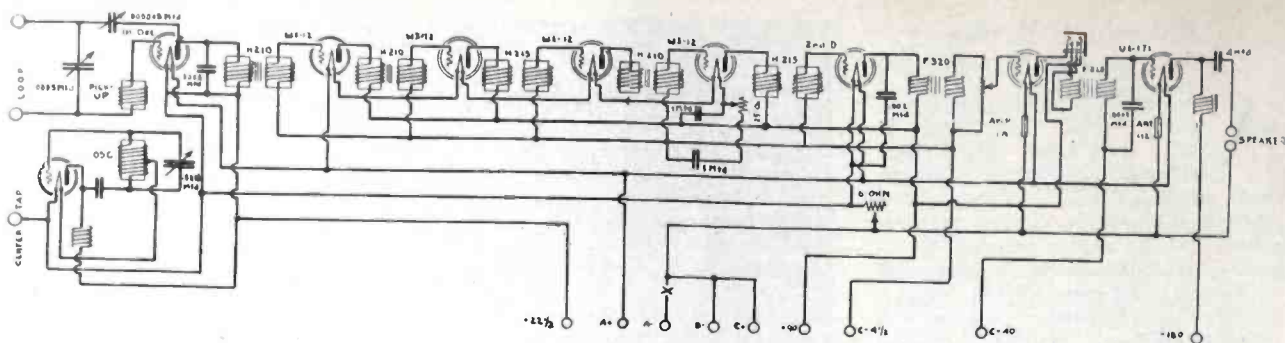

Schematic of the Eclipse Super. Four intermediate stages are employed, in which WX12 tubes, with filaments wired in series, are used. This arrangement greatly promotes the stability of the intermediate amplifier, and reduces the current drain

## The Eclipse Super

*The efficiency of this design gives excellent performance at low operating expense—By Hollis De Neefe*

**I**N our laboratory at Radio Hill, we constructed a super-heterodyne of truly amazing performance. This receiver was so satisfactory, that we conducted a contest in *Radio Mechanics*, in order to obtain a suitable name for it. The name Eclipse, and its attendant monogram, was chosen as being the best submitted.

The circuit used in the Eclipse \*super has been used before, and the many sets made from it have given splendid results. However, our design is entirely new, and the method of layout used is conducive toward even greater efficiency.

All of the intermediate transformers, the choke unit, and the RF transformer have been mounted under the sub panel. Not only does this arrangement simplify the wiring, but it keeps the centers of the tubes away from the centers of the transformers, which is a thoroughly desirable condition.

Viewing the receiver from the front, the loop, or input end is at the right, and the loudspeaker, or output, is at the left. This is the direct opposite of the arrangement ordinarily used, but here again, this method permits of shorter high frequency leads, and still allows a straight sequence of circuits with no crossing of grid or plate connections.

Although this receiver uses nine tubes, the current drain from both A and B batteries is unusually low. This economy is due to a number of reasons. First, every tube in the entire set, with the exception of the first detector and the oscillator, has its grid negatively biased by a C battery. Therefore, the average B current draw of each tube, exclusive of the power tube, is only from 1 to 1½ mills. Further, the intermediate amplifier uses four WX 12 tubes, with their filaments wired in

series, so that the A current drain from this section of the set is only ¼ ampere, and the entire receiver uses only 1¼ amperes.

The tuning of this outfit is exceptionally sharp. However, selectivity has not been pushed to the point where quality suffers. The sharpness of the tuned circuits is due to the accurate matching of the long wave transformers and filters, as well as to the minimization of stray fields and capacities by the use of extremely short leads and proper bypassing. In view of the

speaker. This feature was added, for it is important that a 171 tube be used in the last stage. It would be poor policy to use a 112 type tube in the second audio here, for a good healthy super will overload a 112 about as easily as the ordinary set overloads a 201-A.

This receiver is very stable, and quiet in operation. There are no howls produced in the outfit, since no potentiometer is used on the intermediate grid returns. There is a complete absence of hissing, which is caused, in some supers, by regeneration in the intermediate amplifier, or by unmatched filters and intermediate transformers.

A Quali-tone loop is recommended for use with this set, for it has the proper inductance to strike a balance with the oscillator output. This matching of input circuits, is important, for it avoids overloading of the

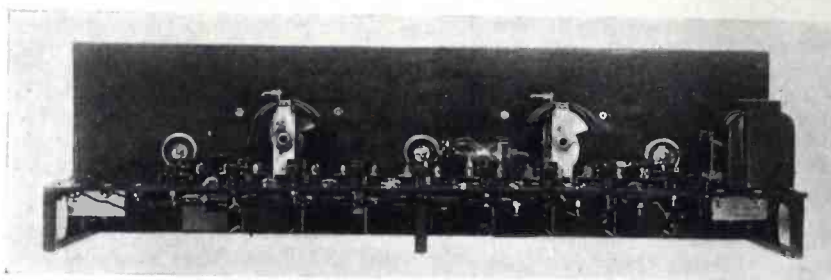

Rear view of the assembled receiver. Note that all transformers are mounted under the sub panel

fact that this nine tube job was wired with twenty feet of wire, it is not surprising that exceptional results should be gained.

As shown in the schematic, the circuit uses the following tubes:

The oscillator, first and second detectors, and the first audio are 201-A's, the four intermediates are WX-12's, and the second audio is a 171. If still greater handling capacity is desired, a 112 can be used in the first audio socket, and no circuit changes are necessary, except that a 112 Amperite should be substituted for the 1A which controls the filament of that tube.

An output coupling device, consisting of a choke coil and condenser, is used between the power tube and loud-

speaker. first detector grid with either of the power sources.

A jack is provided on the front panel, and connects to the first audio stage. This is for the convenience of those who would like to use an external power amplifier, such as the Quality Amplifier described in the November issue of *Radio Mechanics*. This form of amplification is becoming increasingly popular, and therefore, it is advisable to make provision for it on all modern receivers.

Dealers can well recommend this receiver to their parts customers and to the set builders, for this set is one which amply fulfills all the promises of performance expected from super-

\* Complete Construction Article in February *Radio Mechanics*.

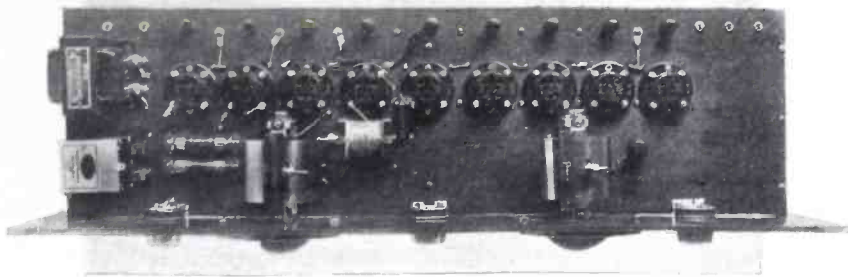

Bird's eye view of the Eclipse Super. Such compact assembly, without the slightest sacrifice of efficiency, is most unusual in a nine tube job.

heterodynes, and gives excellent results at a very low operating cost. Heavy duty B batteries will give long service on this outfit, because of its low current draw, and, therefore, the receiver is suitable for use in rural communities where no power source for B eliminators is available.

The list of parts used in the Eclipse super is as follows:

- 1—Tobe Deutschmann 4. mfd., filter condenser;
- 2—Sangamo .0005 mfd. bypass condensers;
- 1—Sangamo .002 mfd. bypass condenser;
- 1—Yaxley midget filament switch;
- 1—Yaxley junior jack, double circuit;
- 3—Garfield Radion brackets;

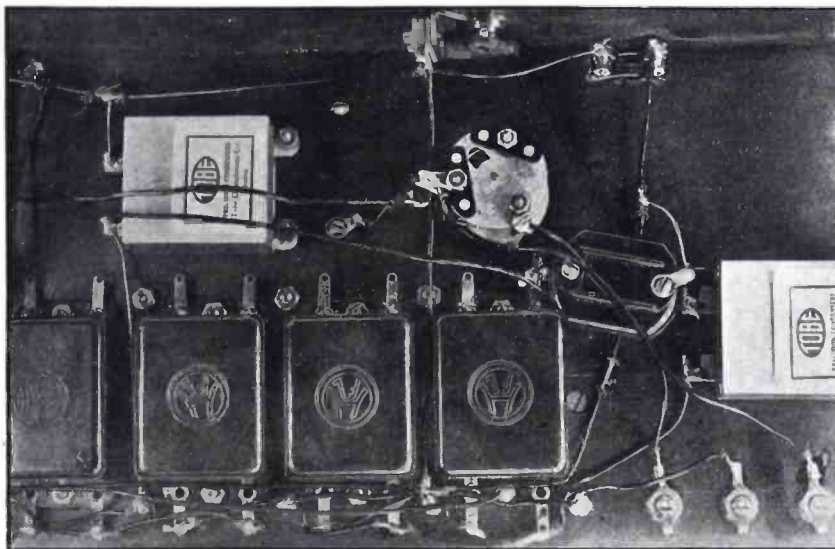

A close-up of the input end of the Eclipse Super. The grid and plate terminals of the tubes are connected directly to the transformer terminals

- 3—High Frequency Laboratories' H-210 transformers;
- 2—High Frequency Laboratories' H-215 transformers;
- 1—High Frequency Laboratories' L-325 RF choke unit;
- 1—High Frequency Laboratories' L-330 RF transformer;
- 2—High Frequency Laboratories' F-320 audio transformers;
- 9—Na—ald spring cushioned sockets;
- 2—Samson S.L.F. condensers. .0005 mfd.;
- 1—Samson No. 85 RF choke;
- 3—Kurz-Kasch rheostat knobs;
- 2—Kurz-Kasch Aristocrat vernier port dials;
- 1—Chelton .000045 mfd., midget condenser;
- 4—Tobe Deutschmann 1. mfd., bypass condensers;
- 1—Carter Imp. 500,000 ohm. Hi-Pot;
- 1—Carter Imp. 6 ohm. rheostat;
- 1—Carter Imp. 25 ohm. rheostat;
- 5—Union tip jacks;
- 9—Eby binding posts;
- 1—1-A Amperite;
- 1—112 Amperite;
- 1—Celeron front panel 7 x 26;
- 1—Celeron sub panel 7 x 25;
- 1—Thordarson R196 choke;
- 1 package Lastites, for 6-32 screws;
- 2 doz. 3/4" flat head 6-32 brass machine screws;
- 2 doz. 3/4" round head 6-32 brass machine screws;
- 4 doz. 6-32 nuts for above;
- 2 doz. tinned soldering lugs;
- 1 roll Cornish "Flexibus wire";
- Rosin core solder.

## Phase Difference in Dielectrics

Insulation materials play a great role in the radio field. Their importance cannot be exaggerated, especially if we consider the minute quantities of electrical energy with which we are dealing. One of the characteristics of insulators or dielectrics is the phase difference or phase angle. Probably a greater number of men are familiar with the term power factor. The phase angle is similar to it, but is designated as the difference between 90 electrical degrees and the power factor angle. Thus for most good dielectrics used in radio, the phase difference will be less than 2 degrees. The perfect dielectric would have a zero phase difference.

J. B. Whitehead prepared an interesting discussion of phase difference and factors influencing its magnitude. This paper was presented before the A. I. E. E., and from the journal of that organization we quote the following:

"The importance of phase difference in dielectrics was first appreciated in its influence on the performance of telegraph and telephone cables. Attenuation, distortion, and internal loss are all increased thereby, thus greatly restricting distances of communication.

"Although phase difference is a property of the material of the dielectric, and although this has been recognized for many years, and although an abundant literature is replete with experimental observations, it is astonishing to find that our knowledge even of the values to be assigned to particular materials is extremely indefinite, and that little has been accomplished towards a systematic understanding and regulation of the factors which control the values of phase difference. Each of the following well-recognized properties or conditions of insulation, if present, will cause a dielectric-phase difference: 1—normal conductivity, 2—dielectric absorption, 3—anomalous conductivity, 4—absorbed moisture, 5—dielectric hysteresis.

Normal Conductivity. We have in conductivity one of the fundamental causes of dielectric-phase difference. It is usually assumed that conductivity contributes a negligible proportion of the losses in dielectrics. This is undoubtedly true for most pure and simple materials, especially at ordinary temperatures. It should be noted, however, that the values of conductivity of different dielectrics extend over a wide range and in many cases may contribute a considerable phase difference. The conductivity of most dielectrics increases rapidly with increasing temperature. The rapidly rising phase difference of such a composite material as impregnated paper, for example, under increasing temperature, may be accounted for in very large measure in some instances by the increase in conductivity alone. The important influence of water on conductivity is described below.



**Dielectric Absorption.** Probably the most important of all causes of dielectric-phase difference is dielectric absorption, i.e., the phenomenon of after-charge and residual charge. It is obvious that if under applied continuous voltage, current continues to flow over a period of time into or through a dielectric, then under alternating voltage there will flow a component of current in phase with voltage, which, of course, means a definite angle of phase difference. Absorbent dielectrics, in effect, have for a short interval after the application of voltage a greatly increased value of apparent conductivity.

Absorption usually occurs whenever a dielectric is composed of two or more different materials. Further, it appears that a very small proportion of a foreign material may cause a large absorption effect. Thus, the absorption often observed in many supposedly pure, simple materials is usually attributed to impurities.

**Moisture.** It will be readily seen that the influence of moisture on the phase difference on insulating materials is very complex. The variation with both voltage and time is often to be found in the alternating case: Increase in the amount of absorbed moisture shows itself almost immediately in increased values of phase difference and loss. As a consequence every effort is made in the manufacture of commercial insulation to ex-

clude moisture as completely as possible and to prevent its subsequent absorption.

**"Anomalous Conduction.** Electrolytic dissociation and resulting conductivity is known to exist in some complex insulating materials. Glass is a remarkable example of this. The metallic constituents of some glasses may be separated out under continuous voltage and deposited on electrodes. Here is an instance of a rigid insulating material through which it is known beyond a doubt that electrolytic ions pass from one electrode to another.

**"Hysteresis.** Since the days of Siemens, who first noted the heating of impregnated paper under alternating stress, it has been customary to attribute the losses in dielectrics to some form of molecular friction, apparently arising in the same types of cause pertaining to the case of magnetic hysteresis. With due weight given to these considerations it may still be said that the evidence that the nature of the losses in dielectrics is of the character usually understood by the word hysteresis and is so small as to make it appear very unlikely.

"Bearing in mind these various causes giving rise to a phase difference in dielectrics, it is not to be wondered at that there is much conflict of evidence as to the behavior under different conditions of insulation of any particular type."

and an excellent cone speaker was attached to the output. Despite the severity of this test, and the wholly unfavorable conditions under which the eliminator was working, no hum was audible at a distance of a few feet from the speaker. When a signal of moderate intensity was being received, no hum could be heard. The above will serve to give some idea of just how excellent is the filtration accomplished by the outfit.

During the above mentioned tests, plate current readings were taken on the individual circuits of the super. The 171 drew 15 milliamperes, which was in line with the drain to be expected, with 140 volts on the plate. A 112 was then substituted for the 171, and the meter fell to 8 mils. However, with the 112, the meter kicked vigorously under strong signals, indicating that distortion was present. Indeed, a meter was not needed to verify this condition, for it was very evident to the listener. The superiority of the 171 to the 112, for handling capacity, was indubitably proved. Some question has arisen as to the performance of these two tubes, when the same voltage is applied to the plate of each, and the proper bias adjustment is obtained.

The first audio amplifier consumed 4 mils of plate current. As said before, there were 120 volts applied to the plate, and the grid was biased 5 volts negative. This bias was obtained by the drop across the filament of the preceding tube. A 5 volt bias, when the plate voltage is 120, is somewhat lower than that recommended on the tube data sheets. In the first audio stage, however, it is advisable to use less bias, for the impedance of the tube is then lower, and, therefore, the tone quality is considerably improved.

The first and second detectors, the oscillator, and the three intermediate frequency tubes, all obtained their B supply from one tap. Seventy volts was found to be the value at which the best results were obtained in this receiver and, at this potential, a total plate current of 11 mils was indicated for these tubes. In the case of the intermediates, the grid returns were made direct to the negative filament of each tube. This arrangement was possible here, for the intermediate amplifier was inherently stable, and no variation of grid bias was necessary. The grid return of each detector was made to the plus F of that tube, for 201-As were used for both detectors, and the grid leak and condenser combination employed for rectification. The oscillator grid return was made to its own negative filament.

These tests were made, and all readings noted, while the receiver was in actual operation. At all times a steady current of 250 milliamperes was flowing through the filaments of the 201-As. This value, added to the 30 mils total plate current, indicated a total drain of 280 milliamperes from the system.

This current divided among the

---

## Additional Data on the O1-ABC Eliminator

*Exhaustive tests on large receivers prove the soundness of this design*

---

**T**HE O1-ABC Eliminator, as first described in the December issue of Radio Engineering, is not limited in its application to receiver circuits. We have conducted extensive laboratory tests on this outfit, and with a wide variety of receivers and circuits. Instead of encountering difficulties and finding any apparent faults with its design, construction, and operation, we have become more thoroughly satisfied with its performance, and are even more sold on its merits. In view of these facts, some of its features and characteristics, noted in the laboratory, will be of interest to all who are interested in AC operation.

As stated in the original article, the rated output of the outfit is 260 milliamperes. This rating, of course, is based upon the figures which accompany the 216-B tubes. As a matter of fact, we have experienced no difficulty in drawing over 300 mils from the device.

As an illustration, the O1-ABC Eliminator was used in conjunction with an eight tube super-heterodyne. Seven of the tubes used were 201-As, with

their filaments wired in series, and the power tube employed was a 171. Six of the 201-As drew B Supply from the 45 volt tap, one from the 90 volt tap, and the full output was applied to the 171 tube.

No difficulty was experienced in obtaining over 100 volts from the 45 volt tap, by varying the adjustable resistance. The same applied to the 90 volt tap, and all readings were taken while the device was under full load. However, it was found that the maximum reading on the high tap, under these conditions was only about 140 volts. This voltage is sufficient, nevertheless, for very good volume and quality, using either the 112 or the 171 type of power tube.

The super-heterodyne referred to was operating from a loop. As a test, the ground wire was removed from the eliminator, and the receiver was placed less than six inches from the O1-ABC. The connections to the electrostatic shields on the power transformers were also removed. The super used very good transformers in the audio end,

216-B rectifiers showed that each was contributing 70 milliamperes to the total output. Each tube was, therefore, only overloaded about 8 per cent. On the other hand, the AC, applied to each 216-B plate, was only 300 volts, and these tubes are rated for a maximum of 550 volts.

During the course of these tests, the 01-ABC Eliminator was in daily operation, sometimes for twelve consecutive hours. The apparatus showed no signs of deterioration or breaking down, and the following characteristics were noted:

First, the power transformers employed, rated at 8.5 milliamperes, became hot in operation, but not dangerously so. This was a very good showing, indeed, for the transformers were operating continuously at a 65 per cent overload. At this point, however, it can be stated that a transformer with a 700 or 800 volt secondary would improve the results gained from the receiver, for a higher plate voltage would then be available for the output tube. Unfortunately, no such transformers, suitable for this purpose, are now manufactured. It is to be strongly recommended that the transformer makers design such a unit.

Second, the chokes used, rated at 85 mils, became only moderately warm, even over long periods of continuous duty. In this case, also, the overload was about 65 per cent. It was clearly

indicated that the chokes were better adapted for this heavy duty than the transformers.

Third, the rectifying tubes employed are perfectly satisfactory for use in this outfit, and they can be expected to give long service under the conditions encountered.

Fourth, the filter condensers, subjected to an operating voltage of 200 volts DC, as they are in this apparatus, will last indefinitely.

Fifth, series wiring of the filaments proved to be a decided advantage, from the standpoints of simplicity and flexibility, as well as performance.

Sixth, the 01-ABC eliminator is a thoroughly practical device, and it can be relied upon for unfailing and satisfactory performance. The results obtained from the laboratory model can be duplicated by anyone, for the outfit is made from standard parts.

From the foregoing, it can be concluded that the 01-ABC Eliminator is the logical solution to one of the most baffling problems that has confronted the engineers of the radio industry.

It is to be hoped that the manufacturers of chokes and transformers will shortly design special apparatus which will be more adaptable for this service. When this is done, the dependability of the outfit will be further safeguarded by a comfortable safety factor.

amplification. In fact, most of the leading radio-frequency receivers now on the market are employing this form of volume control, which permits of bringing the radio-frequency end right up to maximum sensitivity and volume.

In the case of B-battery operation, the plus B lead to the radio-frequency tubes should be provided with a variable high resistance for the best operation, since too much plate voltage is just as fatal to good results as too little. It will be noted that the control of the radio-frequency tube plate voltage by this means does not call for any alteration within the radio receiver itself, since the control can be inserted in the proper lead without the necessity of troublesome mounting.

The plate voltage of the detector and the audio-frequency tubes may also be controlled, if desired, although once the proper values are attained for good tone quality, the voltages should not be changed. It is far better practice to let these values remain at their best settings, and to alter the plate voltage of the radio-frequency tubes as already outlined. Some radio authorities recommend a variable high resistance for regulating the plate voltage of the power or output tube. This is really unnecessary, since, in the first place, a power tube should be employed to handle all the necessary volume without choking or distorting; secondly, the utmost plate voltage within the capacity of the tube should be applied, for best results; thirdly, the C battery should be adjusted to provide the necessary grid bias for whatever voltage may be applied on the plate of the power tube. Hence a variable plate voltage is hardly necessary nor desired for the last or power tube, although it sometimes serves a good purpose for the preceding audio tube or tubes.

Some authorities recommend a variable high resistance in the loud-speaker leads or across the loud-speaker itself. These measures are not usually recommended. The place to control loud-speaker volume is at the beginning of the reception process, or at the radio-frequency end. However, if the loud-speaker is placed at some distance from the receiver, as in the radio-wired home, a variable high resistance may be placed either across the loud-speaker terminals, or in one lead.

The main consideration, in controlling the loud-speaker volume, is to employ a positive form of variable resistance, which not only provides the desired resistance range and current-carrying capacity, but also provides a positive path for the current flow without uncertain contacts, arcs, frying and premature breakdown. Especially is this important in reducing loud-speaker volume, when the variable resistance, because of its increasing resistance and longer current path, is more apt to develop poor contacts, and consequent noises, which will be far more noticeable with reduced signal strength.

---

## Volume Under Control

*Ways and means for regulating the output of the receiver—  
By Charles Golenpaul\**

---

THE intensity of the powerful signals from present-day broadcasting stations, and the use of power tubes, radio-frequency amplification, and high voltages at the receiving end, has made it necessary to provide some means of reducing the loud-speaker volume when desired. In fact, the ideal state of radio affairs is when there is far more volume than is ordinarily required, and a satisfactory means is available of throttling down this volume to any desired degree.

Now, it is one thing to cut down the loud-speaker volume, and quite another to do so without impairing the tone quality. There are correct ways and means of reducing volume, just as there are incorrect ways and means. As a general rule, the sooner the volume is reduced in the process of reception, the better the results. Thus, if the volume control is in the radio-frequency end, the results are bound to be better than if the volume control is placed in the audio-frequency end, after the signals have been needlessly amplified, and where any change is most apt to cause distortion or serious loss of quality.

It is a mistaken idea, yet one that has nevertheless gained very general acceptance, that the simplest volume control is detuning the receiver. This is entirely wrong. Granted that it is the simplest, since it entails no additional attachments, and stands for nothing more than turning one or more tuning controls off the point of sharpest tuning, this method often introduces serious distortion, for the reason that a clean wave is no longer available, and some of the valuable side bands or latent sound components of the signal are chopped off. Also, the variation of the filament current, which is also resorted to as a volume control, is by no means good practice, since the tube functions properly only at the given filament temperature and voltage, and any reduction is certain to result in insufficient electronic emission, followed by distortion.

The most satisfactory method, both from the simplicity and the tonal standpoints, is to vary the plate voltage of the vacuum tubes. In the case of B-battery operation, the best procedure is to insert a dependable variable resistance unit in the B plus lead going to the radio-frequency tube or tubes, or to the detector tube in the event that there is no radio-frequency

\* American Mechanical Laboratories.



# New Cabinets and Shields

Outlining changes in cabinets and shields to conform with new uses and requirements of radio equipment—By M. B. Sleeper

THE effect of women's tastes in bringing radio equipment into the modern home is responsible for prices of receiving sets which range into hundreds and even thousands of dollars, not because of the things inside the cabinet, but because of the cost of the cabinet itself. Now it appears as if the radio set may retire to a modest corner on a closet shelf, with only the loudspeaker, plugged into any one of several convenient outlets, in evidence.

At first, the radio set was admitted to the living room under protest, because of its untidy appearance. Then it was disguised in cabinets and consoles of various designs. But now women may insist that it be put away, out of sight, so that once a station has been selected for the evening's entertainment, there will be no temptation to play with the dials.

The soundness of this new trend will be admitted by anyone who has learned the enjoyment of a good local broadcasting station. If your own home is properly arranged for radio entertainment, you know that it is seldom necessary, during an entire evening, to make more than an initial adjustment. Only the volume may require attention, and that can be done by a control on the loudspeaker plug connected to an extension cord, or else a regulator on the wall plate. In fact, we may have volume controls on the loudspeakers themselves.

This fits in very nicely with the development of new circuit details, so that it is quite possible that the outward appearance of radio equipment may change materially. Some suggestions along this line are given in the accompanying illustrations. While they are only intended to show generalized ideas, they offer a host of possibilities.

In Fig. 1 is the simplest form of "battleship design," as we call it, because of the three decks employed. The vertical panels are of insulating material, one to carry the controls, and the other for terminals. Wooden boards,  $\frac{1}{2}$  in. thick, are used for the decks. Then, when side boards are hinged to the top deck, the set becomes its own cabinet.

Models which we have built at the Radio Hill laboratory were made with vertical panels 7 ins. wide by 12 or 14 ins. high. The decks measured 16 to 20 ins. long by 6 ins. wide. The decks were made narrower than the front panels to allow the side boards to come flush with the vertical panels. With vertical panels 12 ins. high, there is

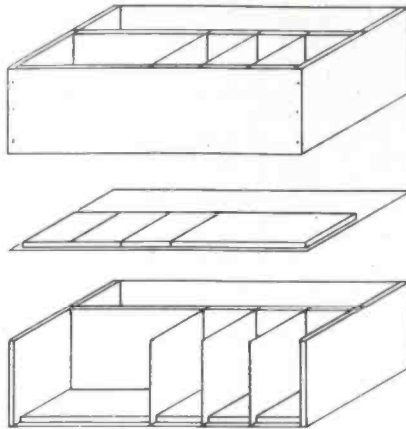

Fig. 3: Combined metal cabinet and shield.

just comfortable space to slip in the tubes.

Now as to the electrical advantages of the battleship design. On a super-heterodyne, the middle deck carries the intermediate circuit, with the first detector and its tuning condenser and coil at the front, feeding the circuit from front to rear. The bottom deck, fed from rear to front, takes the second detector and audio stages, with the oscillator condenser, coil, and tube at the front. This gives a much more complete isolation of the circuits, and greatly reduces the feed-back between

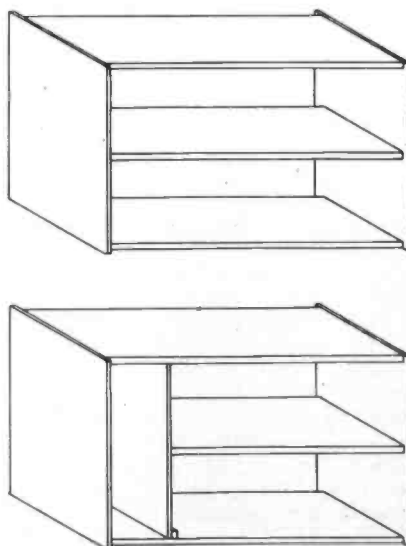

Fig. 1—Above: Plain type of battleship receiver design. Fig. 2: Modification for Victoreen single control condenser unit.

sections over the conventional system of putting the circuits in a continuous line.

A change was made in this arrangement to accommodate the single-control condenser unit for the Victoreen super. This is shown in Fig. 2. Here a vertical sub panel was used so that the Victoreen condenser unit could be mounted vertically behind the front panel. That brought the main tuning control toward the top, with the compensator below. Intermediate and audio circuits were arranged in the way previously described.

The battleship design is not limited to supers, however. It was used for a short wave set with excellent results, and again the gain from separating the R.F. and A.F. circuits was noticeable in greater stability. On the short wave set, we put the coils on the top deck, with their axes parallel with the lengths of the decks. The tuning condenser and detector go in the upper compartment also, with the regeneration condenser and audio circuits down below. So stable is this outfit that, on the broadcast waves, it is practically single control from 300 to 550 meters, and one resetting of the regeneration condenser covers 180 to 300 meters.

Of course, shielding can be applied to this design. With variations, depending upon the circuit employed, the upper compartment can be used to carry all the circuits, and a B or A, B, C eliminator housed in a shield below. Again, a single shaft condenser unit and the R.F. coils can be put below, with all the R.F. tubes and the A.F. amplifier above.

Used in the home, a set of this design might be tucked away in a convenient corner downstairs, or as some people are doing already, put up in the attic where the eliminator or batteries are safe from harm.

This type of set is easily handled, particularly if there is a strap on the top, and it is inherently strong, able to resist far more rough usage in shipment than the present designs.

When you first consider the shape of this kind of set, it may not appeal to you at all, but it is undoubtedly true that it can be used as the basis for some very interesting developments.

To return to more conventional construction, we have spent much time on the design of a shield, suitable for use by manufacturers or to be sold to set builders in knocked down form. Our experience with single-stage shields has not been entirely satisfactory. They make the wiring difficult in many cases, unless the shield is designed for specific parts in a specified circuit, they preclude the use of simple gang condenser units, and are not generally easy to work into complete set design.

We have used, in a most satisfactory way, the type of shield shown in Fig. 3. It is made of sheet metal fastened to  $\frac{3}{8}$  in. whitewood, except

for the front panel, which is Bakelite, or it might be metal also.

At the front is a long compartment for a gang condenser, operated by a drum control. Behind it are three small compartments for R.F. coils and tubes. The last section is for the A.F. circuit.

The side pieces, bottom, center shield, and back are fastened together with wood screws, as the metal pieces are secured to separate wooden pieces, as the illustration shows. Slots in the wood permit the insertion of the plates between the R.F. stages. The top is also grooved, so that it can be pressed into place.

The argument may be advanced that a shield of this sort, depending upon friction contact between metal pieces, is not sufficient. Actually, it has been

demonstrated that the shielding is adequate, and compares in results with sealed joints. Moreover, it seems that in many cases the losses caused by shielding are as essential to proper operation as the isolation of the circuits.

This type of shield, constituting a very attractive cabinet as well, can be assembled easily in jigs arranged to locate the wooden pieces on the metal sheets. Then it can be assembled with great facility, and the parts and wiring put on. As an item for set builders, it is most attractive because, since the parts are fastened to wood, they can be changed or rearranged readily. Two types of shielding made in this way will accommodate practically all the varieties of circuits now available.

---

## Striking Developments in the Radio Field

*A Report from the Department of Commerce*

---

**R**ADIOTELEPHONE commercial service between the United States and Great Britain in the near future is a reasonable probability, according to D. B. Carson, United States Commissioner of Navigation, in his annual report made public recently.

Tests which have been conducted show encouraging results, but, it is pointed out, the difference in time, in connection with office hours of banks, stock exchanges and brokerage houses, may present some difficulty.

Commercial pictoradiogram services, the report reveals, are now in operation between New York and London and San Francisco and Hawaii. By means of this development, photographs, pictures, advertisements, legal documents, bank checks, cartoons, fingerprints, and similar pictorial or printed matter are quickly transmitted and reproduced. This new field, the Commissioner states, may develop into an important branch of radio communication.

Broadcasting stations in this country on June 30, 1926, decreased slightly during the past fiscal year, totaling 528 licensed stations as compared with 571 last year and 535 in 1924. There has been a material increase in power used. The average power per station in watts is 715.8 as compared with 312.4 last year and 190.5 the year previous. During the past fiscal year, 117 new stations were licensed and 160 discontinued. The previous year 281 new stations were licensed and 245 discontinued.

On June 30, there were 14,902 active amateur radio stations in the United States, according to the report. There was a considerable decrease in the number of these stations licensed during the fiscal year as compared with 1925, the figures being, respectively,

8,037 and 10,074. During the year under review 3,209 amateur stations were discontinued. Amateurs in this country, the report points out, are taking advantage of all improvements made in the art, and are inclined to more readily adopt new ideas than is possible with the larger stations, where much experimenting must be done before changes are made which involve large expenditures of time and money. Practically all amateurs are now using continuous-wave transmitters, many of them having crystal control. With the amateurs, the spark set is considered as obsolete as is the crystal receiving set.

At the close of the year under review, there were 1,954 vessels equipped with radio as compared with 1,901 during the year previous. Considerable progress was made during the year in converting spark transmitters on ships to the more modern type tube transmitters, which increase the range of the station and produce much less interference. It is not unusual for ships, equipped with continuous-wave apparatus, tube or arc, to maintain daily communication with land on a trans-Atlantic voyage.

Radio compasses were in use in 230 American merchant vessels at the close of the fiscal year compared with 83 during 1925, the report discloses. The value of this equipment as an aid to navigation and for the purpose of locating vessels in distress is now generally recognized by steamship companies.

Continued growth in the use of radio is predicted by Commissioner Carson, together with improved service to the public. However, he states that in the absence of adequate radio laws, it is difficult to forecast just what the actual conditions may be during the coming winter.

## Announcement

**R**ADIO ENGINEERING for February will contain all the technical and circuit data on the Victoreen Socket-Power Super. This announcement should be of interest to the technical men and dealers, for it means that the problem of successful AC operation of any receiver using storage battery tubes has been finally and definitely solved.

Of course, we cannot give the full details concerning this receiver here, but a short description of its salient features will be of interest to everyone. Briefly, the circuit design is standard, except that the filaments of the tubes are wired in series.

Seven 201-A tubes are employed, and one 171 power tube. However, no batteries of any kind are used on the set. A small loop is the pickup medium, for no antenna is necessary. The whole outfit is very compact, as the front panel measures only 7 ins. by 14 ins.

Aside from the fact that this outfit operates from the light socket, and requires no care or attention, its popular appeal will be further enhanced by the fact that only one dial is used for tuning. Here, then, is the receiver for the man who wants the last word in radio.

The laboratory model has been in operation for several weeks, and its performance has been nothing short of startling. This super combines tremendous pickup, knife-edged selectivity, simplicity of operation, and great volume, with a purity of tone that is amazing.

A complete article and detailed description of the construction of this receiver will be given in the March issue of Radio Mechanics.

---

## Annual Meeting Federated Radio Trades Association

The Federated Radio Trade Associations, consisting of a large group of state and territorial radio trade associations, has selected the Coronado Hotel at St. Louis, Missouri, as the headquarters for its annual meeting and election of officers February 14, 15.

This will be the second annual convention of this group of associations, and it is expected to be largely attended by the radio trade from all sections of the United States, because of its central location and of the interest of trade associations in this national body.

A detailed program of matters to come before this national body, covering a wide variety of problems confronting the industry, is being arranged. The officers of the association are Harold J. Wrape, President of the St. Louis Radio Trade Association, President, A. M. Edwards, Secretary of the Michigan Radio Trade Association, Vice-president and H. H. Cory, of the Northwest Radio Trade Association, as Secretary and Treasurer.



# Tests on Atmospheric

A report covering a long series of tests on transoceanic traffic—  
By M. Baumler \*

**A** PAPER of great interest presented before the I. R. E. was a contribution from M. Baumler of the German Telegraphy department on "Simultaneous Atmospheric Disturbances in Radio Telegraphy." Of course, the phenomenon investigated was interpreted with special reference to that branch of radio. Nevertheless, the facts presented are also of interest to the broadcast field as they should ultimately lead to sufficient data from which an hypothesis on the nature of atmospheric disturbances may be drawn.

"It was previously determined that the effect of a large part of the atmospheric disturbances extends not only over a small area around the receiving station, but that these same disturbances are noticeable at observation points at some distance from each other, and also that the range of the effect of the atmospheric disturbances is at times very large. The method of observation consisted of recording the atmospheric disturbances, along with reference signals, with recording apparatus in two places. The daily time signals from Lyon from 10 o'clock to 10.05 a. m. served as signals for determining simultaneous disturbances. The simultaneous or related disturbances can be determined from the occurrence of the disturbance relative to the simple mark of the time signals. The investigation led to the conclusion that between Grafelfing, near Munich, and Strelitz—a distance of 580 km.—at which places the receiving apparatus was not influenced by local power disturbances, 98 per cent of all recorded disturbances occurred together. Between Berlin and Strelitz, as well as between Hamburg and Strelitz, the percentage of simultaneous disturbances was smaller, as in the large cities local power disturbances occur as well as the pure atmospheric disturbances. The extension of the experiments from Berlin to the east coast of North America—a distance of 6,400 km.—gives similar indications of simultaneous disturbances.

"If one assumes the occurrence of disturbances at great distances as due to the propagation of electromagnetic waves, and that is a prevailing opinion of the nature of the atmospheric disturbances, it is left to try to determine whether disturbances at great distances do occur simultaneously and whether the percentage reaches any considerable amount.

"The continuation of the experiments was made possible through the cooperation of the Radio Corporation

of America, which had already taken part in the earlier experiments. The receiving stations at Kokohead at Oahu, Hawaiian Islands, and Marshall, California, belonging to the Radio Corporation and a special experiment station of the Telegraphentechnischen Reichsamt at Berlin, served as recorder stations. The signals were sent on a wavelength of 17,500 meters from the transmitting station at Rocky Point, WQL, according to the following plan:

Test de WQL	Date
a.....b.....c.....d.....etc. to z.	
Test de WQL	Date
aa.....ab.....ac.....ad.....etc. to az.	
Test de WQL	Date
ba.....bb.....bc.....bd.....etc. to bz.	

"The space between the two letters or groups of letters amounted to 5 centimeters on the transmitting tape, the transmitting speed being 30 words per minute. The transmitting plan proved to be very satisfactory.

"The distance between the transmitting and receiving stations are:

Rocky Point—Berlin.....	6,400 km.
Rocky Point—Marshall...	4,300 km.
Rocky Point—Kokohead..	8,200 km.
Marshall—Kokohead .....	3,900 km.
Berlin-Rocky Point-Marshall .....	10,700 km.
Berlin-Rocky Point-Marshall-Kokohead .....	14,600 km.

"The great circle distance from Berlin to Kokohead, azimuth 8 degrees west of north, amounted to 11,700 km. The ink recorder of the Radio Corporation was used in Kokohead and Marshall, and a recorder similar in construction to the siphon recorders in cable telegraphy furnished by Fa. C. Lorenz, A. G., was used in Berlin. The investigation was carried out from March 1 to March 28, 1925. The transmitting time was from 3.30-3.35 A. M. eastern standard time or 9.30-10.35 P. M. in Berlin, 12.30-12.35 A. M. in Marshall and 10.30-10.35 P. M. in Kokohead. During the investigation it was, therefore, daylight in Berlin and night in Rocky Point, Marshall and Kokohead. The tape of the receiving apparatus was adjusted to a velocity of 1.5 meters per minute. This was not always possible. Photographs of the original tapes show how closely equal spacing of the characters on the various tapes was attained.

"The quality of radio reception is dependent upon the ratio of signal strength to the atmospheric disturbances. If the ratio approaches unity, the possibility of recording decreases and reception is impossible if the signals fall below the disturbances or are otherwise suppressed, i. e., if the av-

erage strength of the disturbance is higher than the signal strength. In the telephone receiver, disturbances of medium strength are noticeable through a continual grinding noise; in the recorder the pen moves back and forth across the tape tracing a non-readable curve.

"Recording of signals from WQL at Kokohead is often impossible due to atmospheric disturbances, as the intensity is very different on various days. Also it must not be overlooked that the transmitting station at Rocky Point, WQL, is intended for traffic with Europe with distances of from 6,000 to 7,000 km., while the distance from Rocky Point to Kokohead is 8,200 km. with the greater part of the distance over land and hence unfavorable to the propagation of the electromagnetic waves.

"A section of a tape taken on March 27, 1925, shows that the letters are somewhat mutilated in Kokohead, but still recognizable. There is no doubt that the disturbance impulses obtained in Marshall are also present in Kokohead. In addition, a few other apparently purely local disturbances are observed in Kokohead.

"On March 14, 1925, simultaneous recording of signals in Kokohead and Marshall took place. The tape at Kokohead is an example of showing the effect of disturbances on the signals. The disturbances are even stronger than the signals. The reason for the smaller number of disturbances recorded at Marshall as compared to Kokohead is that the ratio of the disturbance to the strength of the disturbances was higher than in Kokohead and less amplification in the receiving apparatus necessary. The field strength at Marshall was higher, due to the shorter distance from Rocky Point.

"On the tape of March 10, 1925, from Kokohead and Marshall, individual groups of disturbances can be differentiated which consist of several single disturbances. It must be admitted that the disturbance groups and individual disturbances agree completely at the American receiving stations. The disturbances are less in Marshall as the signal amplitude is greater than in Kokohead, so that here the weaker disturbances appear only a smaller deflection above the zero line. From a count of the common disturbances and the determination of the percentage, and even without going through these computations, it is seen that nearly all of the disturbances recorded occur together and are of the same origin. At first sight, no disturbances common to Berlin and both the American receiving stations are received even when one considers the time interval between the reception of a signal and a disturbance impulse which it is assumed is received first in Marshall. For a tape velocity of 150 centimeters in a minute this difference is about  $\frac{2}{3}$  mm. on the tape. The character of the disturbances in Berlin is apparently quite different from that in

\* From a paper presented before the I. R. E. at the December meeting.

Kokohead and Marshall. On the Berlin tape only a few occasional disturbances are seen.

"According to the present view, as previously mentioned, atmospheric disturbances consist of electromagnetic waves that have their origin in nature's electrical adjustments; one may speak, therefore, of these as natural waves in contrast with the waves artificially generated at a transmitting station. If we consider atmospheric disturbances as electromagnetic waves, then the laws of electromagnetic propagation must hold, that is, the propagation of disturbances must be better at night than during the day and the disturbances considerably reduced during the transition from darkness to daylight or vice versa, that is in passing through a twilight zone. The relative location of the four receiving places with respect to day and night has been previously mentioned.

"The explanation for the large number of simultaneous disturbances at Marshall and Kokohead lies in the good propagation conditions obtaining at night.

"The extent to which disturbances occur simultaneously at different places depends further upon their strength, the distances of the observation points from the source and the sensitiveness of the receiving systems. If the disturbance is very strong, its effect may be felt at widely separated places. It is not, however, to be expected that the number of simultaneously occurring disturbances should reach any large amount and still less so if natural obstacles affect propagation. This accounts for the small number of disturbances common to Berlin and the American observation points. Correlation of the occurrence of disturbances of same origin at still greater distances may be established when proper receiving apparatus is provided.

"Sudden disturbances in the electrical field of the atmosphere, the magnetic field of the earth, displacements inside the earth and electrical adjustments in the cosmos may be the source of disturbances. To the variation in the earth's electrical field belong lightning discharges, most important being the strong lightning discharges in the tropics.

The results of the investigation are summarized as follows:

"A large number of disturbances occur simultaneously in Hawaiian Islands and California, 3,900 km. apart; occasional disturbances occur simultaneously at distance 10,000-12,000 km. apart. The general propagation phenomena of electromagnetic waves are applied to the propagation of disturbances and explain thereby the frequency of the simultaneous occurrence of disturbances.

"It is the intention to continue the investigation and to select the conditions so that the observation points lie entirely in light or darkness, so that more accurate observations can be made under equal conditions."

# Wired Wireless News

*The world's longest system now in regular and successful operation on a 202-mile circuit*

THE world's longest guided radio telephone and telegraph system is now in successful operation between the Vaca-Dixon Substation and Pit River Powerhouse No. 1, by the Pacific Gas & Electric Company. The system utilizes the twin circuit 220,000-volt transmission lines between the two plants for a conducting medium, over a total distance of 202 miles, and is for the sole purpose of directing the operation of the two stations, both under normal and emergency conditions.

The transmitting equipment is the regular vacuum tube telephone transmission equipment, similar to that used by the high powered broadcasting stations. Four 250-watt and one 50-watt Radio Corporation of America

The receiving equipment consists of a Colin B. Kennedy Corporation Type 110 Universal Receiver, which has been modified to make it a non-regenerative receiver, and a Western Electric No. 10-A loud speaking outfit using two stages of audio-frequency amplification.

One of the unusual features is the method of calling which is done by mounting a calling microphone in the horn of the loud speaker, which, when the calling circuit is completed, will oscillate and howl in much the same manner that the ordinary telephone will howl when the receiver is placed against the transmitter. This gives a very loud note whose pitch will depend upon the natural period of oscillation of the diaphragm and which is clearly audible in all parts of the station.

Ordinarily, it is not necessary to use the calling system, as the receivers are always in service, and the operator is near the set. The system is arranged for simple operation, for it is merely necessary to operate a small telephone switch, which energizes a contactor, to connect either the transmitting or receiving set to the antenna, thus permitting talking or listening.

The system is coupled to a transmission line through a single wire antenna about 1800 feet long. This wire is attached to the twin vertical circuit transmission towers at a point on the center line of the tower, and at the elevation of the middle cross arm. Six standard 10-inch suspension insulator units are used for dead ending and supporting the antenna.

Its operation, so far, leaves no doubt as to its dependability under practically all conditions, even with one of the 220-K.V. lines down and grounded, and it is expected to effect communication between the stations under conditions when the wire lines will be out of service.

There are undoubtedly many similar applications for wired wireless communicating systems, and the privacy thus afforded offers an advantage over radio transmission.

That the use of wired wireless may encroach upon the broadcasting field has already been found unlikely. There is no reason for changing except that a monthly charge could be made. However, the fallacy there, as has been pointed out in Radio Engineering before, is that as long as there were radio experiments there would be outlaw listeners.

Beside, the American people are not responsive to the idea of being charged for what they have always got for nothing.

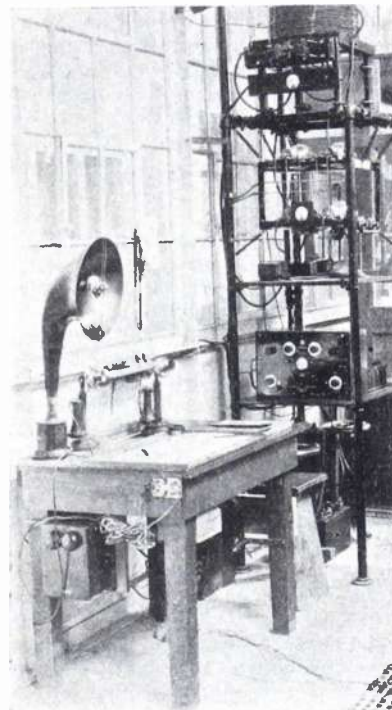

A view of the calling and control room of the wired wireless system.

The method of calling employed is unique. A calling microphone is inserted in the horn of the loud speaker, and gives a very loud note when the calling circuit is completed.

Radiotron tubes are employed, two of the tubes being used as oscillators, and two as modulators, with the 50 watt tube as a speech amplifier. The messages are transmitted to the high voltage power lines, and the waves travel in the immediate vicinity of the wires. They do not interfere with any other transmission, and are not broadcasted.



# Engineering and Financial Stability in the Industry

*Radio Depends Upon Mechanical and Electrical Designing Skill of the Engineer and the Taste of the Artist—*

*By Dr. A. N. Goldsmith\**

RADIO has passed from one definite epoch into another. I think we can all remember the time when a line of eager customers clamored outside of the door of any radio shop ready to buy anything which was alleged to give a signal, even if it was housed in a soap box, take it home and then be amazed at the wonderful feat of hearing a city as much as 20, 30 or 40 miles away. Our job in those days was to put up signs around the counters where the apparatus was being sold to prevent the congestion becoming so great that people were in danger of being trampled to death.

I think we all have to admit that that age has passed. We now have to go out and attract the customer, convince him and sell him something of permanent worth and definite value. The days of pure romance, of casual performance are over; let's resign ourselves to that. It was inevitable. We are getting into a business now which is a lot more like the grocery business and a lot less like the airplane business. In other words, our feet are now definitely on the ground.

If that be the case, we have got to consider "where do we go from here." I think we will all agree, and without sounding a pessimistic note at all, that radio enthusiasm in the average citizen of the United States at times leaves something to be desired. Point 1 is his criticism of receiving sets; Point 2 is his criticism of programs; Point 3 is his very vigorous and sometimes rather lurid criticism of interference, and if I may whisper it, one even hears criticism of that august body that meets in Washington because it has not yet legislated to control a rapidly increasing condition of interference.

Therefore, we must find the answers to these problems in order to maintain the interest and affection, and also to attract the buying power of the people of the United States. How shall we do it. On the transmitting end it is fairly obvious. We have to supply loud, clear programs from a multitude of stations. They have to be diversified, novel, and intrinsically interesting. I want to say at this point that if a radio program is going to be any less interesting than an average vaudeville performance, or an average theatrical performance, we will not be in the radio business five years from

now, because the public is going to insist on programs which are intrinsically important and interesting.

Fortunately, a great many of the important stations of the United States have fully appreciated that fact and are making every possible effort to get the best artists, the most novel of features, the most clever of program arrangements in order that their motto shall really be, "The Listener Be Pleased."

Syndication of programs by wire networks presumably will make it economically possible to hire the best artists and send them all over the country. You cannot hire artists whose fees run into thousands of dollars an hour unless a great many people are going to hear them, because if only half a dozen people hear them, then it is bound to cost each of those half dozen people say \$500. That isn't logical. Therefore, you have got to have something nearer 3,000,000 hear the person who gets \$3,000 for an appearance.

I noticed the other day that a Metropolitan Opera singer walked out on her audience in one of the suburban towns (New Rochelle) because the clink of the dollar was not audible to her highly trained ear. She was right. Artists have to be paid. It is noticeable that grocers and butchers and bakers require that the bills of artists be paid, so we have got to admit that on the broadcasting end the artist has got to be paid; he must to be syndicated; he has got to be carried around the country.

Fortunately that will be done. We are on the verge of an era when programs will go from the Atlantic Coast to the Pacific Coast, from the Canadian border to the Gulf of Mexico, and that will enable the broadcasting of the very finest of artists, the most novel of features to the radio audience.

Furthermore, there is bound to be program diversity. It is not enough to jam something down a person's throat; not everybody wants to listen to the same thing at the same time. People want choice. You have got to give it to them. That will be done by networks of stations and individual stations, all, I hope, vigorously competing. I hope there are enough networks and that they are good ones, that they keep each other on their toes, and that the journalistic profession roast the poor programs on an individual network with all their accustomed vigor so that the next morning the pro-

gram manager who has been scorned will go out and do a better job for the next evening.

On that score, however, I am not worried. I can see that programs are going to become better and that there is going to be program diversity, and that higher power in the broadcasting station is going to mean better service to the listeners because of the elimination of static disturbances and all the other casual electrical disturbances incidental to human life. Just as I say, I have no concern.

But I have definite concern relative to the present situation on interference. There isn't the faintest doubt in my mind that if there is an indefinite multiplication of radio stations, we will have a situation which I can perhaps make clear by an analogy. Suppose that a gentleman who wanted to sell a handsome sedan car walked up to you and said, "Mr. Jones, the roads are now so congested that if you try to drive you will have your mud guard smashed, your headlights knocked off, your radiator bent and your license plate removed, and in addition all the paint will be scraped off your car; in fact, you will be lucky if you don't limp into the hospital with a loud heterodyne squeak." What would you say to that amiable salesman? You would say to him, "My dear Sir, at this moment I am not interested in your product. Get some system of traffic control whereby the streets will become safe for ordinary human beings and then I will look at your interesting car and decide whether or not I want to buy it."

That is exactly what we face in radio. We have gotten into a jam and the traffic has become hopelessly congested. It is strictly necessary that the conclusions so wisely reached by the Legislative and Public Relations Committee of this Association in its recent meeting in Washington and ratified by the National Coordinating Committee of the Radio Industry, shall be carried into practice. We hope Congress can reach some measure of permanent value and pass it. I mean a bill which will give some sensible administrative scheme, but in any case we have got to have emergency control. Somewhere we have got to have the air cop who stands with his hand lifted up and stops the people who are just colliding with everybody and preventing anybody from enjoying the privilege of the roads. That is a real problem. I believe that will be met. Our amiable President has told us what is going on in Washington, and I think the situation will be met. I am very hopeful.

We come, however, to our own problem at this point, namely, what do we have to do? We have now criticized everybody else, the people who furnish the programs, the people who don't furnish the legislation, or will furnish it. Now let's criticize ourselves. What must we do? As I see it, we depend on two people—the artist and the engineer. We sell engi-

\* An address delivered before a meeting of the R. M. A.

neering brains and artistic taste. If we sell anything else, I don't know what it is. That means that our products are necessarily the result of a carefully worked out, technically sound design, housed in such a way that it shall be attractive to everybody.

There are a number of characteristics of radio receivers which I have listed briefly. They may be interesting. They are the ones, at least, we always think about most when we are considering radio receivers. One is simplicity. Nobody likes too many gadgets, too many knobs, too many controls, too many things to go wrong. Complexity, so far as the user is concerned, is not a happy thing in general. The listener wants relaxation, not a game of indoor "knob ping-pong." He doesn't like that.

In the second place we have got to have selectivity. I might almost say that at the present time you can't build a selective enough receiver because there are too many stations on the air. In fact, it is not conceivable that when stations produce audible notes with each other, audible squeaks and howls, that any receiver will separate them (except directionally, of course) and at the same time preserve good musical or speech quality.

Nevertheless, many of us in the past have not been, and some of us perhaps today are not providing adequate selectivity in our receivers. We must do so. A man wants to listen to the particular program in which he is interested. Imagine how a theatre goer would feel if he decided to go to the X theatre and his taxi driver insisted on driving him to the Y theatre. He would protest and get another taxi driver. We do that sometimes to the listener, and we have got to see that we don't do it in the future.

The third thing we have got to give listeners is good volume in a receiving set. It would be beautiful if all people lived in quiet homes far out in the country where nobody ever passed, where children were silent, where fans didn't buzz, where windows never had to be opened, and where none of the multitudinous noises of daily life interfered with reception, but they don't. You have got to design a receiver so that with the windows up and with the gentleman selling strawberries on the street below as he passes along, with the fan buzzing and the people in the next room talking the listener can still hear what is going on. He may not get the full enjoyment but he will still be able to hear. That is a serious requirement and it takes quite a little volume to do that, more than you would think, until you begin to investigate the question in detail. That which looks mighty fine in a laboratory may look very poor in the home if one doesn't take account of that requirement.

Then, too, a receiver has got to have good quality of reproduction. Of what avail is it if you get a lot of sound if it is merely noise, if speech is not clear, if music is not natural?

I will admit that the tolerance of the average human being for horrible sounds is almost incredible. I have been in homes where people have turned on sets and said, "How do you like that?"

Well, nobody likes to lose a friend, so I have said very little. I am reminded of something that Mark Twain once said. He had borrowed a horse from a friend of his and it was a wretched, decrepit old nag that crawled along the dusty highway at about two miles an hour. When he brought it back, his friend said to him, "Well, Mark, what do you think of that horse?" and he stood up in a proud position, obviously awaiting a complimentary answer. Mark thought a moment and said, "Well, you know Bill, I never saw lightning go like that horse."

That is the situation in radio. I have never heard music go like some receivers. It is a fact. True, they are old receivers, but one of the things we have got to do is to educate the public to the notion that a receiver that still works, in the sense that you can turn it on, isn't a receiver that ought to be in anybody's home today. In other words, we have got to resell the public in a great many cases to keep up with radio progress.

Another feature in design is reliability. The best receiver in the world is worse than the worst receiver in the world when it stops working, because you don't hear anything then, and silence is not golden, not for the radio manufacturer. So that it is definitely important that when a radio set is dropped off the rear end of a truck in its case and carried into the home of the user and parked on his sitting room table that it shall operate just as if nobody had ever treated it badly. That means reliability and it means putting a lot of mechanical cleverness into design.

We are just talking in the family here about what we would like to see. None of us can hope to achieve this one hundred per cent. It is too difficult a job, but the public doesn't like it in the measure in which we don't achieve it and we, therefore, must approximate to it as time goes on.

Appearance is very important in a receiver. The lady of the house objects to having a monstrosity in the living room. She figures that the place for all sort of odds and ends is either in the garret or in the cellar, and neither of them have good acoustics for radio. So that if you are going to compromise with the lady of the house, which means doing what she says, you are going to have to have an attractive receiving set. Therefore, you must have people with artistic taste as designers. I may say at this point that a man might be able to design a beautiful radio in the mechanical sense but you wouldn't want it in your house. So it is very important to have people of artistic taste gradually getting into the radio field and improving the furniture standards of radio equipment.

Last but not least there is the factor of cost. After all, if a thing costs one dollar more than a man has he thinks it is mighty nice but it isn't the thing he is going to buy (unless you get him on the installment plan). But there is a limit to that or else his bookkeeping system will give him a nervous breakdown once a month. So that you have got to "go easy" on that. It is possible to overdo even the installment system at a certain point.

What are these factors that I have mentioned, then? They are all engineering and artistic factors; they all bear out what I have said, namely, that the future of the radio art depends definitely upon the mechanical and electrical designing skill of the engineer and the taste of the artist.

In times of depression in any business the natural thing to do is to discharge somebody. Some people can be relatively easily replaced. The market seems to be pretty full of them, but you can't relatively easily replace an engineer. That is a sad fact. The engineer is a part of the general staff; he is a part of the skeleton organization, and it is not sound policy to let any engineer who is going to preserve the continuity and improvement of your line go, even if there is a certain financial sacrifice involved in that.

For a little while we can, of course, "get away" with almost anything. One can build gaudy apparatus that looks fine until the purchaser gets it home, runs it for a day or two, and then it breaks down; but no permanent structure is built on that.

The Radio Manufacturers Association is made up in a large majority of those elements of the field that are permanent; and if they are permanent, they have got to assume the dismal obligations of permanency which means stable engineering and artistic stuffs and definite regard for these various principles that I have set forth.

Mind you, I am not preaching idealism or altruism or any other ism; I am just talking dollars and cents. And the engineer's job is simply to enable the organization with which he works to make a profit out of applied science. That is all I am discussing here. Of course in this process you will be upholding the ideals of radio, you will be pleasing the public, and you will be increasing public confidence. If the policy is the opposite, it is my firm belief that the confidence of the public will gradually be shaken; you will see more and more frivolous and biting cartoons in the newspapers and elsewhere; you will see the leaders of thought in the community beginning to object to what radio receivers can do and what radio programs are like, and our art may retrograde markedly. If, on the contrary, we live up to this, I see no reason why radio should not permanently remain one of the greatest industries in the United States, and I believe that the men in this room can make it so on the basis of the principles that I have discussed.



# With The Manufacturers

Current news about the activities and plans of the radio manufacturers and concerns which make things used by the industry

## Amsco

Amsco Producers Inc., Broome and Lafayette St., New York, is now in production on a new device known as the Orthophone.

The Orthophone keeps the DC out of the loudspeaker windings, and thereby increases the handling capacity of the speaker, and improves the quality of reproduction. It also adapts the impedance of the speaker to the impedance of the power tube.

The list price of this device is \$6.00.



The Amsco Orthophone facilitates the use of a high powered tube with any receiver.

## Gold Seal

The Gold Seal Electrical Company, 250 Park Avenue, New York City, is manufacturing a complete line of tubes. These are made in all standard types, such as the G S X 201-A, GSX199; the half-ampere power types, such as the GSX112 and the GSX171, and a super sensitive detector, the GSX 200-A.

The GSX171, as illustrated, is designed for the last stage of audio only. A maximum applied plate voltage of 180 is recommended, and a grid bias of about 40 volts.



Type GSX 171

The Gold Seal 171 Power Tube has excellent handling capacity for strong signals.

## Hammarlund

The Hammarlund Manufacturing Company, 424 West 33rd Street, New York City, is making a small variable condenser with a very wide capacity range. This device is designed for use as a neutralizing condenser in sets using the bridge method of balancing tube capacities, but it is also adaptable as a compensator for the units of gang tuning condensers.

The base is of bakelite, and the plate is of phosphor bronze. Mica is used for the dielectric. The maximum capacity is 50 mmfds., and the minimum is 2 mmfds.

The list price of this device is 50c.

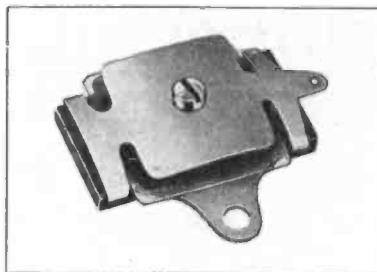

The new Hammarlund neutralizing condenser.

## Eby

The H. H. Eby Manufacturing Company, 4710 Stenton Avenue, Philadelphia, is making a new vernier dial. This dial operates on the friction principle, and a circular metal shield is provided behind the bakelite front. The list price is \$2.50.



The Eby Shielded Vernier Dial.

## Valley

The Valley Electric Company, 4515 Shaw Avenue, St. Louis, Mo., is making a B power unit, which employs the Raytheon tube for rectification.

Two connections are provided on the primary of the power transformer, so that the total output can be regulated to meet varying conditions of line and load. The detector voltage is variable from 10 to 90 volts, and the intermediate voltage is variable from 45 to 135 volts.

The list price is \$40.00.



The Valley B power unit provides adjustable voltages to suit the requirements of any receiver.

## Sangamo

The Sangamo Electric Company, Springfield, Illinois, is making a full line of filter condensers and blocks for B eliminators.

The series A type is rated for continuous operation at 250 volts AC, or 400 volts DC; the series B type is rated for continuous operation at 500 volts AC, or 1,000 volts DC.



Sangamo high voltage filter condenser.

## General Radio

The General Radio Company, Cambridge, Massachusetts, has a full line of B eliminator and power amplifier kits.

Two types of kits are put out for the 171 tube as the power amplifier. One is designed to use the Rectron 213 as the rectifier, and the other employs the Raytheon BH for this purpose.

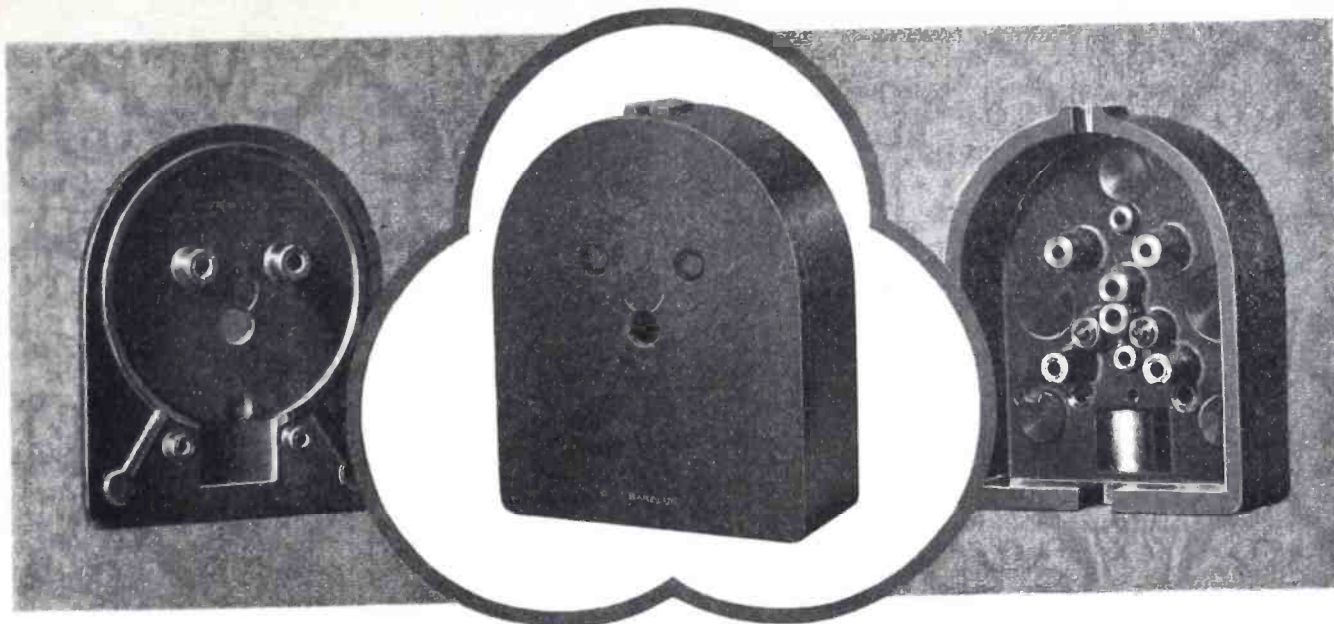

*Bakelite molded housing for Zeco Speaker unit,  
made by Zisch Mfg. Co., Newark, N. J.*

## Bakelite housing improves tonal quality

In the Zeco cone loud speaker Bakelite is used for the housing primarily because of its high insulating properties and the accuracy with which it can be molded.

In addition, it has been found that, by using Bakelite instead of metal for the housing, distorting vibrations are eliminated and the tonal quality of the entire speaker is distinctly enhanced.

Radio manufacturers are constantly discovering new possibilities in Bakelite molded, and are enlisting the cooperation of our engineers and research laboratories in adapting the advantages and economies of Bakelite to their own particular needs. We welcome inquiries.

*Write for Booklet 38*

### **BAKELITE CORPORATION**

247 Park Ave., New York, N.Y. Chicago office, 636 W. 22nd St.  
**BAKELITE CORPORATION OF CANADA, LTD.**, 163 Dufferin St., Toronto, Ont.

# BAKELITE

REGISTERED

U. S. PAT. OFF



THE MATERIAL OF A THOUSAND USES

"The registered Trade Mark and Symbol shown above may be used only on products made from materials manufactured by Bakelite Corporation. Under the capital "B" is the numerical sign for infinity, or unlimited quantity. It symbolizes the infinite number of present and future uses of Bakelite Corporation's products."



# Radio Coordination

Full text of the report made to the  
Congressional Conference Committee\*

**T**HE Coordinating Committee of the radio industry, representing all branches of that industry, the organized transmitting amateurs, some 16,000 in number, through one of the signers hereof, many organized Broadcast Listeners' Leagues of the United States and, through our many contacts the great unorganized radio listening public, takes this opportunity to present to the members of the Conference Committees of the Senate and the House the views of the radio industry and the public as a whole on the legislation which is pending in conference.

These views are the result of a very careful study of the problems not only confronting the industry but confronting you as the men who are immediately responsible for the legislation. We submit these views with the knowledge that they express the attitude of the radio industry and the radio public on the vital matters which are before you, and in the hope that they may be of material assistance to you in your consideration of legislation.

If this Committee, which is truly and wholly representative of radio in America, can be of assistance to the members of the Conference Committees of the Senate and the House, we are at your service.

## Emergency Control

It is the opinion of the Coordinating Committee that it is highly essential to secure legislation controlling radio during this session of Congress. To this end it appears that two distinct steps are necessary.

1. The enactment of an emergency control measure, which will prevent the further complication of an already complicated situation by prohibiting the issuance of any more licenses for the operation of radio broadcasting stations after December 6, 1926.

2. The bringing out of conference of a comprehensive and adequate general law governing the whole radio industry.

The emergency control measure is necessary, in our opinion, because broadcasting stations are now increasing at such a rate—to be specific, one a day—as to cause not only confusion on the air but the possibility of even greater confusion. It is estimated reliably that there are now more than twenty million citizens of the United States who are enthusiastic listeners to radio programs; that more than five million citizens of the United States are the owners of radio receiving sets; that the investment of these citizens as individuals in radio is upwards of

\$1,500,000,000, to say nothing of the investment which broadcasting companies and commercial operators have in the industry.

Unless immediate steps are taken by Congress to prevent confusion in the air, this great radio listening public, together with its large investment in radio, is likely to suffer a tremendous injury.

Equally important is the threatened interruption of the flow of information regarding agricultural and market reports, upon which our farmers have come to depend, through the medium of the radio.

The emergency control measure is suggested as a measure anticipating the enactment of a permanent control law. Two Bills are now pending in conference, one having been passed by the House, and the other by the Senate. The differences between these Bills are such, and the problems involved are such, that the conferees say it will take them some time to settle their differences and solve their problems. We feel earnestly that the conferees can, and should, settle their differences and solve the problems and bring before the Congress an adequate radio Bill; but, pending this solution, we also feel that the Congress should take action to prevent any further complication of the general situation.

## Form of Control

This Committee is aware of the many interpretations of the effect of the two forms of radio control provided in the Senate and House Bills. It is also aware of the wide difference in the terms of these two forms and the consequent differences of opinion on this subject. From the point of view of legislative expediencies the Committee would prefer not to pass upon this subject, or make a statement in favor of one of them, but feels obliged in this important matter to express an opinion based solely on its idea of the good of the industry and the radio listener.

This Committee urges that, in the discussion of this matter and in the final decision, whether it is a compromise or not, the imperative need of immediate legislation compels the acceptance of some principle of control if failure to agree will prolong and increase the difficulty of legislation. It is true that any form of control might be made effective, at least until corrective measures can be taken, if experience proves the necessity for a change.

It is the business of the Conference Committee to settle this matter. We assume the Conference Committee realizes that it can not permit further de-

lay to jeopardize a national industry involving six hundred million dollars per year, and, more important, the disappointment of twenty million people in a very vital and personal family interest.

Having made our position clear in its intent and purpose, the Committee, eliminating all considerations except those for the good of the radio listener and the industry, and the existing subject matter in the Senate and House Bills, favors a control consisting of two bodies—a Federal Radio Commission and the Department of Commerce, whose functions shall be as determined in the House Bill. These functions should be so adjusted in the administrative powers as to clearly determine the standards used in cases for decisions as hereinafter recommended, and to define and clarify large discretionary powers and control in the Commission.

The Committee understands that this proposed Federal Radio Commission has full appellate powers and can hear and decide cases arising both in and outside of the Department of Commerce, and that there is a final appeal to a Federal Court from the decision of the Commission.

The method by which these bodies are created is satisfactory to the Committee, but this and other details are not important enough, in comparison to the main principle, to require detailed opinion from us.

Our reasons for arriving at this conclusion are too many to write into this opinion and might raise controversies that would defeat our intention to serve you. We are aware of the fact that this statement, therefore, is in effect arbitrary but sincere, and, we feel, an intelligent choice in the interest of the industry and the radio listener. In making this decision the Committee does not attempt to pass on the effect of any other form of control not now contemplated, or which might grow out of a future deliberate legislative process, for the practical reasons stated above.

This Committee is willing to leave the future of radio to future Congressional action, believing that the urgent necessity of the present will be best served by immediate legislation.

## Qualifications for Commission Appointment

This Committee believes that any limitation, in addition to the fact that a man must not be financially interested in radio at the time he is serving on the Commission, restricts the number of men from whom selection can be made to serve ably on the Commission because of their current knowledge of radio problems.

## Rights

In our consideration of the Bills in your Committee, we find a specific statement and several references to a principle of "vested property rights."

To be continued in *Radio Engineering* for February, 1927

\* Presented December 2, 1926.

# Directory of Equipment and Apparatus

Readers interested in products not listed in these columns are invited to tell us of their wants, and we will inform the proper manufacturers. Address Readers' Information Bureau.

## AMPLIFIERS, RESISTANCE:

Allen-Bradley Co.  
Leslie F. Muter Co.

## BATTERIES, DRY:

National Carbon Co.

## BINDING POSTS:

H. H. Eby Mfg. Co.

## BRASS:

Copper and Brass Research Ass'n

## CHOKES, RADIO FREQUENCY:

Samson Electric Co.  
Silver-Marshall, Inc.

## CHOKES, AUDIO FREQUENCY:

Samson Electric Co.

## CHOKES, B ELIMINATOR:

American Transformer Co.  
Dongan Elec. Mfg. Co.  
Jefferson Elec. Mfg. Co.  
National Co.  
Thordarson Elec. Mfg. Co.

## COILS:

Aero Products, Inc.  
Hammarlund Mfg. Co.  
Samson Electric Co.  
Silver-Marshall, Inc.

## COIL FORMS:

Samson Electric Co.  
Silver-Marshall, Inc.

## CONDENSERS, FILTER:

Leslie F. Muter Co.  
Sangamo Electric Co.  
Tobe Deutschmann Co.

## CONDENSERS, FIXED:

Aerovox Wireless Corp.  
Dubilier Radio & Condenser Corp.  
Electrad, Inc.  
Leslie F. Muter Co.  
Polymet Mfg. Corp.  
Sangamo Elec. Co.  
Tobe Deutschmann Co.

## CONDENSERS, VARIABLE:

Allen D. Cardwell Mfg. Corp.  
Hammarlund Mfg. Co.  
Karas Electric Co.  
Silver-Marshall, Inc.  
X-L Laboratories.

## COPPER:

Copper & Brass Research Ass'n

## DIALS:

H. H. Eby Mfg. Co.  
Karas Electric Co.

## ELIMINATORS, B:

All American Radio Corp.  
Grigsby-Grunow-Hinds

## GRID LEAKS:

Allen-Bradley Co.  
Electrad, Inc.  
Arthur H. Lynch  
Polymet Mfg. Corp.

## INSULATION, MOULDED:

Bakelite Corp.

## JACKS:

Carter Radio Co.  
Electrad, Inc.

## KITS, RECEIVER:

Donle-Bristol Corp.  
Hammarlund-Roberts  
United Scientific Laboratories

## LACQUER:

Egyptian Lacquer Co.

## MAGNETS, SPEAKER:

D. K. Bullens Co.

## METERS:

Jewell Elec. Inst. Co.

## PANELS:

American Hard Rubber Co.  
Bakelite Corp.

## POTENTIOMETERS:

Allen-Bradley Co.  
Carter Radio Co.  
Electrad, Inc.

## RESISTANCES, FIXED:

Allen-Bradley Co.  
Carter Radio Co.  
Electrad, Inc.  
Arthur H. Lynch  
Leslie F. Muter Co.  
Polymet Mfg. Corp.

## RESISTANCES, VARIABLE:

Allen-Bradley Co.  
American Mechanical Labs.  
Carter Radio Co.  
Central Radio Labs.  
Electrad, Inc.  
Leslie F. Muter Co.

## SPEAKERS:

All American Radio Corp.  
Amplion Corp. of America

## SOLDER:

Chicago Solder Co.

## SOCKETS:

H. H. Eby Mfg. Co.  
Silver-Marshall, Inc.

## TESTING INSTRUMENTS:

Jewell Elec. Inst. Co.

## TRANSFORMERS, AUDIO:

American Transformer Company  
Dongan Elec. Mfg. Co.  
Jefferson Elec. Mfg. Co.  
Karas Elec. Co.  
Leslie F. Muter Co.  
Silver-Marshall, Inc.  
Thordarson Elec. Mfg. Co.

## TRANSFORMERS, POWER:

All American Radio Corp.  
American Transformer Co.  
Dongan Elec. Mfg. Co.  
Jefferson Elec. Mfg. Co.  
Silver-Marshall, Inc.  
Thordarson Elec. Mfg. Co.

## WIRE:

J. A. Roebling's Sons.



# CLAROSTAT

plays a  
leading  
role in



*every circuit.....  
every B eliminator*

**I**N almost every circuit sponsored by RADIO ENGINEERING — in over 90% of the nationally known B eliminators, CLAROSTAT, **the greatest variable resistor**, is functioning daily—silently, smoothly and powerfully.

This universal recognition is easily explained by the fact that CLAROSTAT alone covers the entire range—from practically zero to 5,000,000 ohms; has a carrying capacity of 20 watts without the slightest trace of packing, arcing or crackling noises; acts as the perfect voltage control in B eliminators and as oscillation control in T.R.F. sets.



Invaluable to Fans! "THE GATEWAY TO BETTER RADIO"—32 pages covers everything . . . reception, transmission, amplification, and battery elimination. Send 25c in stamps or coin to

Dept. R. E.

**American Mechanical Labs., Inc.**  
285 N. 6th St., Brooklyn, N. Y.

## USE THESE COILS AND IMPROVE ANY RADIO RECEIVER!

**AERO COIL**  
SUPER-SENSITIVE  
INDUCTANCE UNITS



**TUNED RADIO  
FREQUENCY KIT**  
**\$12.00**

The Aero Coil Tuned Radio Frequency Kit illustrated above will positively improve the performance of any receiver. Patented Aero Coil construction eliminates radio frequency losses and brings tremendous improvement in volume, tone and selectivity. Kit consists of three matched units. The antenna coupler has variable primary. Uses .00035 condenser. 8-page color circuit, layout and instruction sheet for building the super-sensitive 5-tube Aero-Dyne receiver packed FREE with each kit. Extra copies, 75c each. Instructions include insert showing how to wire up for a power tube if desired.

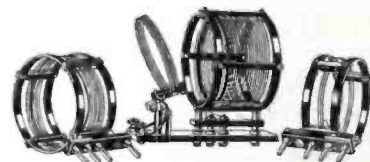

**LOW WAVE TUNER KIT**  
**\$12.50**

Completely interchangeable. Adapted by experts and amateurs. Range 15 to 130 meters. Includes three coils and base mounting, covering T. S. bands, 20, 40 and 80 meters. You can increase the range of this short wave tuner by securing coils Nos. 4 and 5. Combined range of 15 to 550 meters. Both interchangeable coils fit same base supplied with short wave kit and use the same condensers. Coil No. 4 price \$4.00; Coil No. 5 price \$4.00.

*Get these Coils from your nearest dealer. If he should be out of stock, order direct from the factory.*

**AERO PRODUCTS, INC.,**  
Dept. 17, 1772 Wilson Ave., Chicago, Ill.

# ELECTRAD

## A Little Thing to Look At But a Big Thing In Your Customers' Sets

You know how important a factor in insuring good reception is the right grid leak. Here's one that will make a satisfied customer of everyone to whom you sell it.

### ELECTRAD

#### Metallic Leaks and Resistors

give clearer reception with greater signal strength. No carbon, paper, varnish or fiber. The metallic resistance element is fused to the inside of a glass tube. Noiseless, accurate, non-inductive, non-hydroscopic. Uniform in all weathers and working conditions. Capped with the exclusive Electrad ferrule. Impregnated under high vacuum. Great current-carrying capacity without overheating or change of resistance. List, 60c—in Canada 85c.

Write for details of our square dealer proposition that helps you sell and protects your profits.



Write for information on the Electrad 500,000-ohm compensator for perfect control of tone and volume. 428 Broadway, New York City.



# ELECTRAD

# Bradleyometer

## THE PERFECT POTENTIOMETER

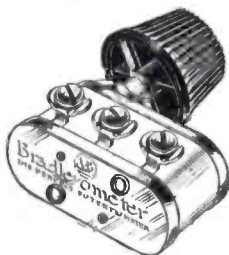

The Bradleyometer is noninductive

Uses graphite disc resistors which are noiseless and not affected by atmospheric conditions. Metal parts are nickel plated. One hole mounting. Finish and knob match Bradleystat. Made in 200 and 400 ohm ratings.

**Allen-Bradley Co.**

Electric Controlling Apparatus  
288 Greenfield Ave., Milwaukee, Wis.

## DO YOU KNOW THAT THE INVERSE DUPLEX

IS to be put out in an entirely new design, incorporating important developments, with a combination of manufacturers behind it? Watch for the complete data in RADIO ENGINEERING.

\$2.00 per year.—Sold only by subscription

Radio Hill, Poughkeepsie, N. Y.

At WGN

# SANGAMO

Mica Condensers

Prevent

Shifting of Frequency Bands



**B**ECAUSE the Sangamo condenser is solidly molded in bakelite, mechanical movement of the dielectric or plates is impossible. This is one important factor in the permanent accuracy of the Sangamo.

No one has greater need for condenser accuracy than a great broadcasting station like WGN. Read Mr. Leverett's comment:

"Last June I used Sangamo Mica Condensers in a multiple band pass filter. This has been in use for some time, and has given the best of results, showing no shifting of the frequency band. This permanency I believe is due entirely to the consistency of these condensers, there being no apparent change in capacity nor leakage across them. I cheerfully recommend them wherever a constant capacity is required.

(Signed) Geo. H. Leverett,  
Asst. Engineer"  
Station WGN Chicago

### Sangamo Condenser Blocks



American-made condensers, wound under uniform tension to eliminate air or ozone bubbles that cause breakdowns.

Handy sizes:

12 mfd. tapped 8, 2, 2 mfd.  
14 mfd. tapped 8, 2, 2, 1, 1 mfd.  
14 mfd. tapped 4 (high voltage), 4, 2, 1,  
1, 1, 1 mfd.

Also separate condensers; special capacity blocks to order.

## SANGAMO ELECTRIC COMPANY

6332-11

Springfield, Illinois

RADIO DIVISION, 50 Church Street, New York

SALES OFFICES—PRINCIPAL CITIES



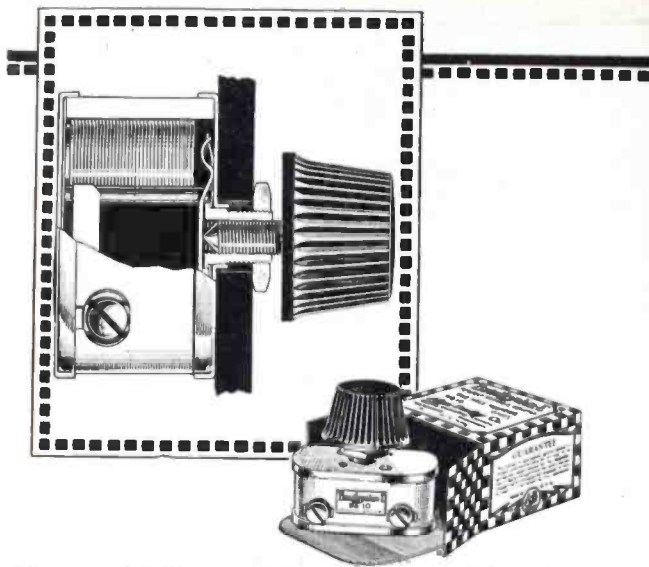

## Use Allen-Bradley Resistors for B-Eliminator Hook-Ups

THE success of a B-Eliminator hookup depends as much on the operation of the variable and fixed resistors as it does on the type of circuit used. Allen-Bradley variable and fixed resistors lead the field for this service. Use them in your B-Eliminator hookup.

### Bradleyohm-E PERFECT VARIABLE RESISTOR

This new oversize resistor is used as standard equipment by leading B-Eliminator manufacturers such as Acme, All-American, Majestic, Philadelphia Storage Battery, and Willard. It is the ideal variable resistor for controlling plate voltage output. The scientifically treated discs in Bradleyohm-E provide stepless, noiseless, plate voltage control, and the setting will be maintained indefinitely. Do not experiment with makeshift variable resistors, when Bradleyohm-E has been pronounced the ideal unit by the largest manufacturers of B-Eliminators in the world. Ask your dealer for Bradleyohm-E when you build your B-Eliminator.



### Bradleyunit-A

**PERFECT FIXED RESISTOR**  
Another triumph of the Allen-Bradley Research Laboratory is Bradleyunit-A, a perfect fixed resistor that contains no glass, requires no hermetic sealing, and can be soldered into place without the use of clip mountings. Bradleyunit-A is not affected by temperature or moisture and it maintains its calibration indefinitely.

MAIL  
THE  
COUPON

ALLEN-BRADLEY COMPANY,  
288 Greenfield Ave., Milwaukee, Wis.

Please send me your literature on Allen-Bradley radio devices and B-Eliminator hookups.

Name .....

Address .....

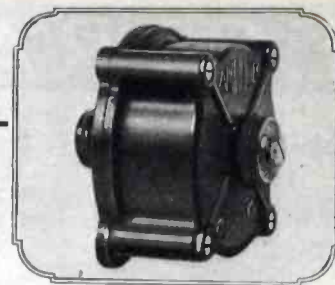

The Amplion unit helps any set to give its best performance.

## Many set manufacturers have accepted our offer of cooperation—

Our engineering staff is at your service for all problems of enclosed units and matching unit to your set electrically.

We will be glad to discuss these matters with you at any time.

The Amplion Corporation of America  
Suite W, 280 Madison Ave. New York City

AMPLION

## Our Complete Line



### STANDARD "B" SUPER "B" MASTER "B"

takes care of practically any Radio receiver on the market. The demand for Majestic Radio B Power units has long existed. It fills the need for **Constant, Dependable B** power direct from the light socket—and fills it well. Their low purchase costs place Majestic units within the reach of all. Their sturdy construction insures long, faithful service.

No Acids or Liquids—  
Uses Raytheon Tube

Now you can get the cream of the B power unit business, for Majestics deliver **constant, dependable, B** power at a low average cost of about one-tenth cent an hour. Our complete line offers you one of the biggest money making opportunities you will ever have in radio! Write us today for full information.

Price includes Raytheon tube.

**Majestic Standard-B**  
For sets having not more than seven 201-A Tubes, or six 201-A plus one power tube.  
Price ..... \$32.50  
West of the Rocky Mts.. 35.00

**Majestic Super-B**  
Capacity 1 to 12 tubes, including the use of power tubes. Complete with switch to control current from light socket.  
Price ..... \$36.00  
West of the Rocky Mts.. 37.50

**Majestic Master-B**  
Rating 60 mls at 150 volts. Particularly adapted for Radiola 25-28 and 30 and super heterodynes, will operate all power tubes also the new super power tube UX-171 (180 volts).  
Price ..... \$42.50  
West of the Rocky Mts.. 45.00

GRIGSBY — GRUNOW — HINDS CO.

4568 Armitage Avenue

Chicago, Illinois

*built with*

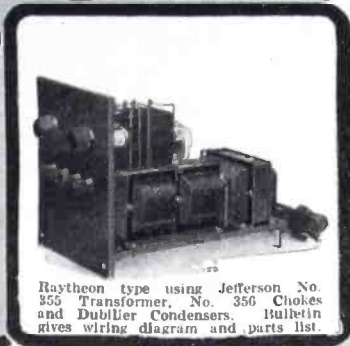

Raytheon type using Jefferson No. 355 Transformer, No. 356 Chokes and Dubilier Condensers. Bulletin gives wiring diagram and parts list.

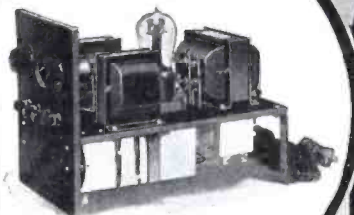

Filament type using Jefferson No. 355 Transformer, No. 356 Chokes and Tobe-Deutschman Condensers. Bulletin gives wiring diagram and parts list.



Raytheon type using Jefferson No. 355 Transformer, No. 353 Chokes and Potter Condensers. Bulletin gives wiring diagram and parts list.

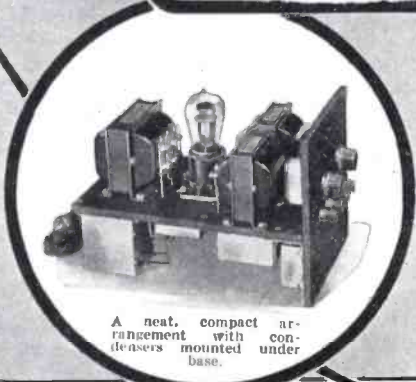

A neat, compact arrangement with condensers mounted under base.

### Write for Free Bulletin:

**"HOW TO BUILD A NOISELESS AND POWERFUL 'B' ELIMINATOR."**

THERE is real satisfaction in building your own "B" Power Supply Units. These are free from noise or hum, are variable, and furnish ample power for sets of 8 tubes or less.

Jefferson Transformers and Choke Coils are used by many leading makers of eliminators. List Price No. 355 Transformer, \$7 each; No. 356 Choke, \$4.00 each.

**JEFFERSON ELECTRIC MFG. CO.**

*Largest manufacturers of small transformers*

542 So. Green St.

Chicago, Ill.

# Jefferson Transformer and Chokes

**Oh boy**  
**KESTER**  
*Rosin Core*  
**Radio SOLDER**

*Sure is Safe and Simple*  
 APPROVED BY RADIO ENGINEERS  
 A GENUINE SOLDER  
**CHICAGO SOLDER COMPANY**  
 4224 Wrightwood Av., Chicago, U.S.A.

*Originators and World's Largest Manufacturers of Self-Fluxing Solder*  
 YOUR DEALER CAN SUPPLY YOU

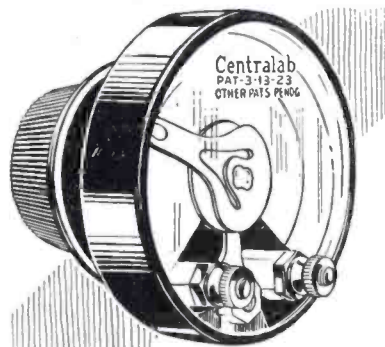

CENTRALAB RADIOHM

## Centralab Products

CENTRALAB RADIOHM

Radiohms, Modulators and Potentiometers sell at

\$2 each

Switch-Type Radiohms at \$2.30

Are specified for many of the most popular of the season's Radio Circuits including Varion, Infradyne, Henry Lyford, Bruno, Improved Browning-Drake, and as voltage or C-bias controls in many of the new power packs including AmerTran.

This is merchandise that you can profitably recommend to your customers; it is fully guaranteed to give satisfaction.

**CENTRAL RADIO LABORATORIES**

25 Keefe Avenue, Milwaukee, Wis.

Modu Plugs, standard or cord type, at \$2.50





used  
in the  
LC-27



# AEROVOX

"Built Better"

## FIXED CONDENSERS are Specified in

LC-27

Diamond of the Air  
To be announced soon(?)  
Raytheon "B" Eliminator  
Ultradyn  
To be announced soon(?)

by L. M. Cockaday  
"Herman Bernard"  
"John Rider"  
"Raytheon Mfg. Co."  
"R. E. Laeault"  
"R. E. Laeault"

AEROVOX fixed condensers have been approved  
by M. I. T. and Yale Universities.

AEROVOX WIRELESS CORP.  
489-491-493 Broome Street  
New York

### See That Screw

A screw-driver ad-  
justs an X-L in  
crowded places



## X-L VARIO CONDENSER

RESULTS in easier  
tuning, more distance,  
volume and clarity—greater  
stability. Indorsed by leading  
authorities.

Model "M" a slight turn obtains correct tube  
oscillation on all tuned radio frequency circuits.  
Neutrodyne, Roberts two tube, Browning-Drake, McMurdo  
Silver's Knockout, etc., capacity range 1.8 to 20 micro-  
microfarads. Price \$1.00

Model "G" with grid clips obtains the proper grid capacity  
on Cockaday circuits, filter and intermediate frequency tuning  
in heterodyne and positive grid bias in all sets. Capacity range Model G-1  
.0002 to .0001 M F D. Model G-5 .0001 to .0005 M F D. Model  
G-10 .0003 to .001 M F D. Details on request. Price \$1.50

X-L Push Post. Push it down with your thumb, insert wire, remove pressure  
and wire is firmly held. Releases instantly. Price 15c

Seven Push Post Panel permanently marked in white on black insulating  
panel. In box including soldering lugs, raising bushings and screws for  
mounting, etc. Price \$1.50

X-L RADIO LABORATORIES 2423 Lincoln Ave.,  
CHICAGO, ILL.

### R. M. A. REPORTS

The full text of the R. M. A. reports are published in Radio Engineering. Committees of the Radio Manufacturers Association are doing important, constructive work, vital to the development of the industry. These reports are of special usefulness to concerns supplying radio manufacturers. Read them in Radio Engineering Magazine.

\$2.00 per year—Sold only by subscription.

Radio Hill, Poughkeepsie, New York

## BUILD THE NEW SHIELDED HI-Q RECEIVER

Thoroughly  
tested circuit,  
newest features  
and guaranteed  
parts selected  
for perfect syn-  
chronization  
produce reception  
unexcelled by  
ready-made sets  
worth \$200 or  
more!

\$63.05

Cabinet  
extra

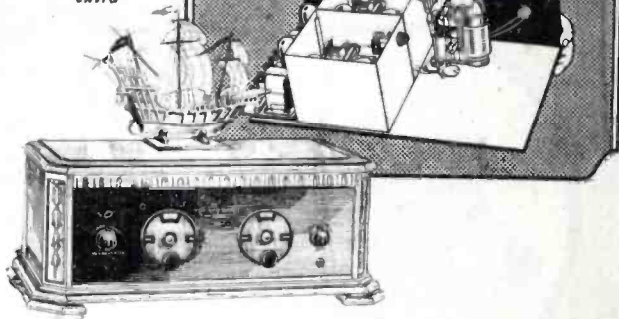

## Build Your Own Masterpiece!

IMAGINE a radio without  
oscillation, without variation  
of volume on different wave  
lengths! Imagine a 5-tube receiver  
with the power of most expensive  
8-tube sets! Imagine knife-like  
selectivity even in crowded areas.  
And imagine tone quality that is  
clear and pure as the natural un-  
broadcast signal!

That describes the 1927 Hi-Q  
Receiver! Automatic Variable  
Coupling and complete stage shield-  
ing are two important new features.  
And the group of *guaranteed* parts  
selected by ten of America's lead-  
ing Radio Engineers completes this  
triumph of modern radio design.

You can build this wonderful  
receiver yourself at home in a few  
hours and save at least \$50 over a  
factory-made set of anything like  
the same efficiency. Get the "How  
to Build" book to-day from your  
dealer and have the receiver de-  
signed by Radio's Master Minds.



The simplest  
and most com-  
plete instruc-  
tion book ever  
printed. Cov-  
ers every detail

25c

Associated  
Manufacturers  
Benjamin Electric  
Mfg. Co.  
Carter Radio Co.  
Durham Resistors  
Eby Mfg. Com-  
pany  
Hammarlund  
Mfg. Company  
Martin-Copeland  
Co.  
Radiall Com-  
pany (Amper-  
ite)  
Samson Electric  
Co.  
Sanyamo Electric  
Co.  
Westinghouse  
Mlcarta

# Hammarlund ROBERTS Hi-Q

\* High ratio of reactance to resistance. High ratio—Great selectivity—  
Loud signals

Hammarlund-Roberts, Inc. 1182-G Broadway, N. Y.

# Chosen by EXPERTS

GLENN H. BROWNING, Laurence M. Cockaday, Gerald M. Best and many other eminent radio designers use the Lynch Metallized Resistor in their experimental circuits and receivers. These men know radio; they have laboratory and testing equipment with which quickly to make accurate comparisons. There could be no better proof of the true merit of the Lynch Metallized Resistor than the endorsement of these experts.

Comprising a concentrated metallized deposit one-thousandth of an inch thick upon a rigid core, sealed forever within a glass tube, the Lynch Metallized Resistor gives *conductive, non-arcing* resistance that remains silent, accurate!

Dealers—Write us!

ARTHUR H. LYNCH, Inc.  
Fisk Bldg., Broadway & 57th Street  
New York, N.Y.

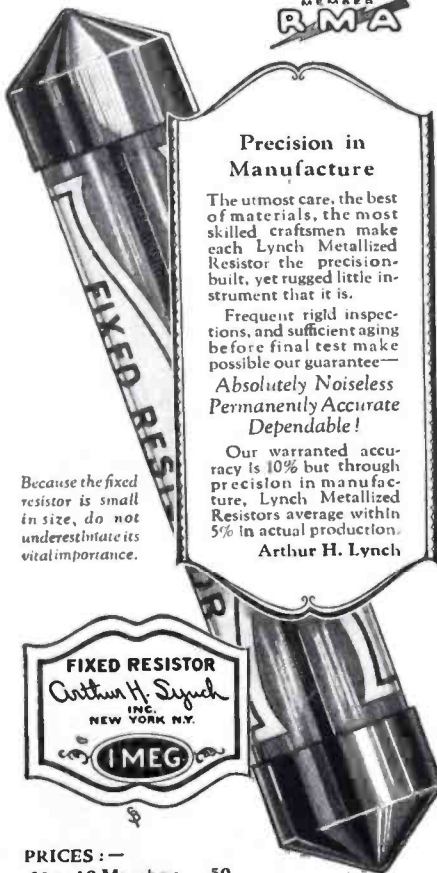

### Precision in Manufacture

The utmost care, the best of materials, the most skilled craftsmen make each Lynch Metallized Resistor the precision-built, yet rugged little instrument that it is.

Frequent rigid inspections, and sufficient aging before final test make possible our guarantee—

*Absolutely Noiseless  
Permanently Accurate  
Dependable!*

Our warranted accuracy is 10% but through precision in manufacture, Lynch Metallized Resistors average within 5% in actual production.

Arthur H. Lynch

Because the fixed resistor is small in size, do not underestimate its vital importance.

#### PRICES:—

.25 to 10 Megohms	.50	Single Mounting	.35
above .01 to .24 "	.75	Double "	.50
.001 to .01	\$1.00		

Lynch Metallized Resistors cost no more than the ordinary kind. If your dealer cannot supply you it will be well worth your while to wait for the mail—we ship post-paid, at once.

# LYNCH METALLIZED

## FIXED RESISTORS

Radio Engineering, January, 1927

# NATIONAL POWER AMPLIFIER

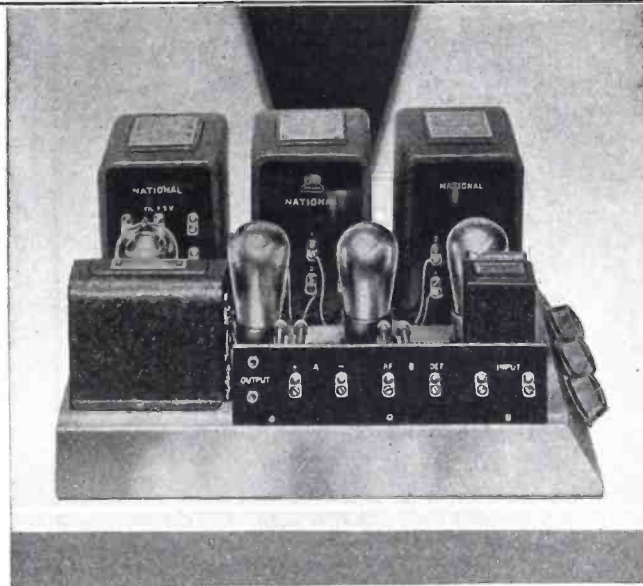

Attaches easily to your present set. rests in a console beneath it, banishes B-batteries—once adjusted requires no more attention—omits *nothing* for fidelity of audio amplification at natural volume.

The modern broadcast station puts its beautiful programs on the air through a faultlessly designed amplifier. The NATIONAL Power Amplifier attached to your present Radio set, passes on the program to you unchanged, lifelike and real. Don't blame the broadcast station for poor reception until the NATIONAL Power Amplifier has squarely placed the blame on it. For with this fine new instrument the quality is limited only to that of the station you are listening to.

Price, completely assembled and tested (without tubes)—\$89.00  
Raytheon BH Tube extra—\$6.00

Sold also in kit form with full instructions for assembly in an evening.

Price of kit (with Raytheon BH Tube, but without audio tubes)—\$84.00.

National products are built to engineering standards of excellence. Anyone who has ever built a set using National Browning-Drake Coils and Transformers knows what that means. Send for Bulletin 116RE.



National Company, Inc., Engineers and Manufacturers—W. A. Ready, Pres., Cambridge, Mass. Makers of National Browning-Drake Coils and R.F. Transformers, Impedance Transformers, Condensers, Power Transformers, etc., for Radio.



# HAMMARLUND Condensers and Coils

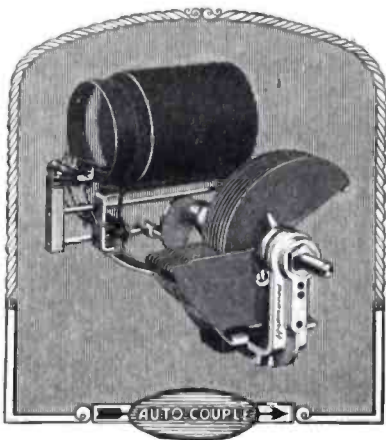

*Used in Many of the  
Season's Featured  
Circuits*

What better evidence of Hammarlund leadership could there be than the fact that twenty-seven recognized designers—men who "know their stuff"—selected Hammarlund Precision Products for use in these outstanding 1927 receivers.

LACAULT "LR4"  
HENRY-LYFORD  
CARBORUNDUM  
NEW HARKNESS  
LOFTIN & WHITE  
ST. JAMES SUPER.  
COCKADAY "LC27"  
BROWNING-DRAKE  
VICTOREEN SUPER.  
PACENT "ULTIMAX"  
MORRISON "VARION"  
SARGENT "INFRADYNE"  
HAYNES "DX2-MULTI-VALVE"  
HAMMARLUND-ROBERTS "HI-Q"  
POPULAR SCIENCE  
MONTHLY "POWERFUL"

We shall be pleased to refer to the proper authorities any inquiries regarding the above circuits.

**HAMMARLUND MFG. CO.**  
424-438 W. 33rd Street, New York City

For Better Radio  
**Hammarlund**  
PRECISION  
PRODUCTS



**GENTLEMEN**  
*We thank You!*

**MANUFACTURERS,**  
Distributors, Dealers—your splendid patronage has made for us a wonderfully successful year. Polymet has grown during 1926; expanded until today we face the new year stronger than ever before; the "World's Largest Manufacturers of Radio Essentials," indeed!

We take this opportunity of renewing our pledge of conscientious, personal service and the painstaking production of the highest quality merchandise. And we wish you all a very happy, prosperous New Year!



Polymet Manufacturing Corporation,  
599H Broadway, New York City  
"World's Largest Manufacturers of Radio Essentials"

**P O L Y M E T  
P R O D U C T S**

# PIERCE



# AIRO

## Complete Assembly for a SIX TUBE RESISTANCE-COUPLED SINGLE DIAL RECEIVER

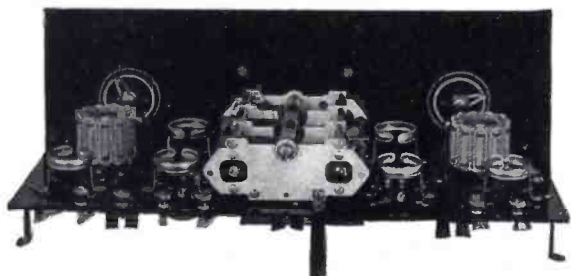

Front and Interior Panel View

### Scientifically Perfected and Built

Install the Pierce-Airo Complete Assembly in your own models and save time and expense of manufacturing. It is a mechanically and electrically perfect product. Pierce-Airo fits all standard cabinets and consoles now on the market. It meets the season's demand for simplicity of operation and pure tone by scientifically combining single dial control and resistance-coupled amplification. No live dealer can afford to overlook this unusual opportunity to sell Pierce-Airo Complete Assembly. Let us quote on your requirements TO-DAY.

Pierce-Airo Complete Assembly with a 7 x 18 Processed Bakelite Panel, Ready for Wiring... **\$42.50**

Pierce-Airo Chassis Wired \$45.00

Write TO-DAY for Proposition

UNITED SCIENTIFIC LABORATORIES, Inc.  
82 Fourth Avenue, New York City

Branch Offices  
Boston  
Chicago  
Philadelphia



Branch Offices  
Minneapolis  
San Francisco  
Los Angeles

## Mr. Radio Engineer

- To—Simplify set operation.
- To—Solve all tube control problems.
- To—Avoid the possibility of distortion in reception.
- To—Decrease servicing need.
- To—Lower production costs.

COMMUNICATE—with an organization that has specialized in filament control ever since Radio was born.

### Radiall Company

50 Franklin St., New York, N. Y.

Makers of



The "SELF-ADJUSTING" Rheostat

## Bradley-Amplifier Resistance-Coupled PERFECT AUDIO AMPLIFIER

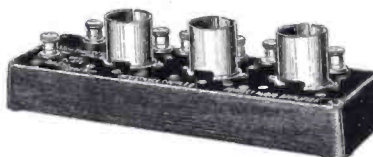

Provides audio amplification with minimum distortion. Bradleyunit molded resistors used in the Bradley - Amplifier do not vary with age and are not affected

by atmospheric conditions. Can be used to replace transformer amplifiers in standard radio sets with decided increase in tone quality.

288 Greenfield Avenue

**Allen-Bradley Co.**  
Electric Controlling Apparatus

Milwaukee Wis.

## THE NEW LOOP SET FROM BOSTON

DO you know about it? The first data on this set will appear in RADIO ENGINEERING.

\$2.00 per year—Sold only by subscription

Radio Hill Poughkeepsie, New York



# Cardwell Condensers

Introducing

The

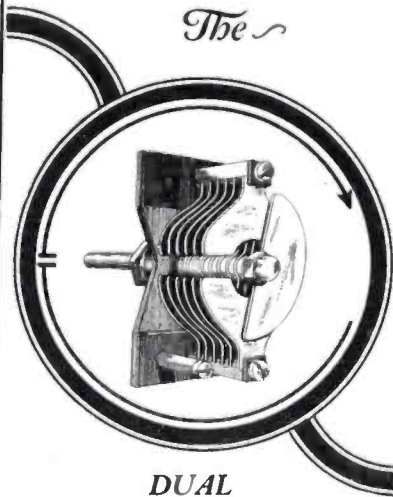

DUAL

**"BALANCET"**

Type	Capacity*	Price
610-A	.000015	\$2.00
614-A	.000025	2.25
626-A	.000050	2.50

\*Each side

## PRACTICAL SINGLE CONTROL

Can be accomplished by the use of the new Cardwell **"BALANCET"** and DUAL **"BALANCET"**

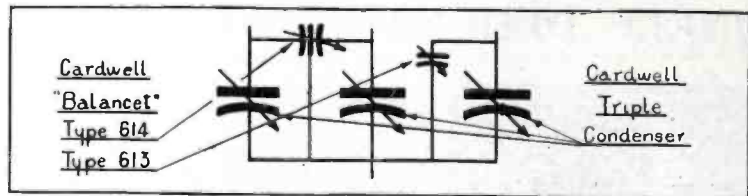

Illustrating the use of the Cardwell "BALANCET" for perfect synchronization of a triple condenser. The trimmers may be placed inside the set or attached to the panel.

**"THE STANDARD OF COMPARISON"**

Send postage for illustrated folder containing descriptions and circuits.

The Allen D. Cardwell Mfg. Corp. 51 PROSPECT STREET BROOKLYN, N. Y.

## ANOTHER NEW CARTER

PRODUCT



\$1

(Full size)

**"MIDGET"**  
Rheostat  
with  
Filament  
Switch

First and ONLY self-cooling all-metal frame rheostat with filament switch.

Springs are actuated by a cam which closes filament circuit as soon as knob is turned from "Off" position. Separate filament switch eliminated. Operation simplified. Space conserved.

2; 3; 6; 10; 15; 20; 25; 30; 40; 50; 75 Ohms.

In Canada: Carter Radio Co., Limited, Toronto

At Your Dealers



RMA



New Products

### Tinytobes

The TINYTOBE Condenser, shown in actual size above, is a new product and is available in capacities from .0001 to .02 Mfd. For continuous operation at voltages up to 500 volts D.C. It is so small and light that it can be soldered directly into the circuit without other support.

Prices range from 35c for the .0001 Mfd., to 60c for the .02 Mfd.

TOBE Condensers are specified in the Quadraformer, Carborundum, Lincoln, Henry-Lyford, Browning-Drake, Eclipse Super, Samson, T. C., and many other leading circuits.



### Tobe Radio Interference Filter No. 1

A complete, compact piece of equipment, for a reduction of Radio interference caused by oil-burner, refrigerator and other household motors up to 1/4 H.P. Made to be easily attached direct to the source of the trouble, not to the Radio set. The design avoids damage to capacitors or slip-rings, sometimes encountered when condensers only are used. Write us for particulars and price list.—A. R. E.

Tobe Deutschmann Co.

Engineers and Manufacturers of Technical Apparatus  
Cambridge, Mass.

## Testing of Radio Apparatus

We make a specialty of testing condensers at radio frequencies

### Electrical Testing Laboratories

80th St. and East End Ave., New York City

## LACQUERS

FOR THE

## RADIO INDUSTRY

### Egyptian Lacquer Co.

Dept R. E.

90 West St., New York City

## D. K. BULLENS CO.

*Stock Magnets for Loud Speakers*

*Permanent Magnets to Blue Print*

**Pottstown, Pennsylvania**

## WIRE

STRAND—Antennae (plain or enameled)—Double Galvanized.

WIRE—Antennae (plain or enameled) Connecting and Ground (Rubber) covered, braided or plain.

BUS BAR—Litzendraht-Loop.

MAGNET (Cotton or Silk).

**John A. Roebling Son's Co.**  
Trenton, N. J.



B-6 Tube \$5

## Announcing -

Because of the ready acceptance of the B-6 tube and the circuit we have developed for it, and to comply with general request, we announce a kit in two forms and a complete set built to the specifications of this circuit. Send for complete literature.

**THE DONLE-BRISTOL CORP.**

Division S,

MERIDEN — CONN.

## PHILADELPHIA

Chestnut and 39th Street

## Hotel Pennsylvania

Fireproof—Unrestricted Parking—Garage



OSCAR W. RICHARDS, Manager

**600 ROOMS—500 BATHS**

Rooms with running water from \$2.50 per day

Rooms with private bath and shower from \$3.50 per day

*Food and Service the Best*

Near West Philadelphia Station Pennsylvania Railroad  
University of Pennsylvania—Franklin Field



# RADION

## Panels and Parts

Complete protection of all circuits is a prime consideration in radio operation. The electric impulses must pass through the circuit without the possibility of leaks.

Repeated tests have proved that Radion has the lowest angle phase difference. That its dielectric constant is lowest. Its resistivity highest (megohms-cm). Its power loss factor lowest. Its moisture absorption lowest.

Radion parts are made to meet your insulation needs. Whether molded, stamped or machined—they can be furnished in Radion.



**CRACKLE SURFACE**

**PANELS**  
*Help Sell Sets*

Ace Crackle Surface Panels resemble Rich Spanish Leather. They have attracted wide attention. They add materially to the sales possibilities of a set.

Ace Crackle Surface Panels possess the well-known insulating qualities of hard rubber. They can be supplied in all standard sizes,—ready cut. Special sizes if required.

Let us send you sample pieces, and parts, with quantity prices.

*Jobbers and Dealers write for price list.*

**AMERICAN HARD RUBBER CO.**  
11 Mercer Street, New York City

### Working Data on Glow Tubes and Rectifiers

Official data from Radio Corporation on the use of these tubes in new eliminator circuits. This information is of great importance to engineers working on eliminator designs. Special data is given for constant voltage control for 180 volts on 171 tubes. SEE THE FEBRUARY ISSUE.

\$2.00 per year.—Sold only by subscription

**RADIO HILL**

**POUGHKEEPSIE, NEW YORK**

## INDEX OF ADVERTISERS

A	PAGE
Aero Products, Inc.....	548
Aerovox Wireless Corp.....	552
Allen-Bradley.....	549, 550, 555
American Hard Rubber Co.....	558
American Mechanical Labs.....	548
American Transformer Co. Back Cover	
Amplion Corp. of America.....	550
B	
Bakelite Corp.....	546
Bullens, D. K.....	557
C	
Carter Radio Co.....	550
Cardwell, Allen D. Mfg. Corp.....	550
Central Radio Labs.....	551
Chicago Solder Co.....	551
Copper & Brass Research Ass'n.....	550
D	
Dongan Elec. Mfg. Co., Inside Back Cover	
Donle-Bristol Corp.....	557
Dubilier Condenser & Radio Corp.	526
E	
Eby, H. H., Mfg. Co.....	580
Egyptian Lacquer Co.....	557
Electrad, Inc.....	549
Electrical Testing Labs.....	557
G	
Grigsby-Greenow-Hinds .....	550
H	
Hammarlund-Roberts .....	552
Hammarlund Mfg. Co.....	554
Hotel Pennsylvania .....	557
J	
Jefferson Elec. Mfg. Co.....	551
Jewell Elec. Inst. Co.....	559
K	
Karas Electric Company.....	521
L	
Lynch, Arthur H.....	553
N	
National Carbon Co. Inside Front Cover	
National Co., The.....	553
P	
Polymet Mfg. Corp.....	554
R	
Radiall Co.....	555
Roebing, J. A. Son's Co.....	557
S	
Samson Elec. Co.....	580
Sangamo Elec. Co.....	549
Silver-Marshall .....	525
T	
Thordarson Elec. Co.....	523
Tobe-Deutschmann Co.....	556
U	
United Scientific Labs.....	555
X	
X-L Radio Labs.....	552



# Developments—

that are new in Radio  
**1926 Contributions**

Pattern No. 116 B-Eliminator Voltmeter 0-50-200 volts (800 ohms per volt).

Pattern No. 117 Radio Service Set.

Pattern No. 120 B-Eliminator Tester.

A-B Relay (an automatic trickle charger and B-Eliminator switch).

Study the above items carefully and you will see a real need for each. They were all introduced by Jewell and are fast filling their place in the radio field.

Jewell has contributed much to the success of the radio art and industry.

Write us direct about your radio problems and be sure to ask for a copy of our radio instrument catalog No. 15-C.



Pattern No. 120 B-Eliminator Tester is for adjusting B-eliminator taps to the individual requirement of the radio set with which the B-Eliminator is to be used. The B-Eliminator under test is connected to the terminal on the tester and any desired load in milliamperes is placed on it by the adjustable rheostat. The actual B eliminator voltage available under that condition is then shown by the voltmeter and will be an indication of the adjustment needed. Form No. 1030 describes this device in detail.

**JEWELL ELECTRICAL INSTRUMENT CO.**

1650 Walnut St., Chicago

"26 Years Making Good Instruments"



# NEW



**Dependable Products**

—for the 1927 Season

Endorsed and used by leading set builders

**Quality at Popular Prices**

May we send you our complete catalog? Write Dept. R. E.

**LESLIE F. MUTER CO.**

76th and Greenwood Avenue  
 CHICAGO, U. S. A.



**Audio Frequency Transformers**  
 Highly efficient—primary price fully covered by an increased metal case.  
 100 ohms.....\$1.00 list  
 250 ohms.....\$1.25 list  
 500 ohms.....\$1.50 list



**Variable High Resistance**  
 Controls excitation and regulates quality and volume. Highly etched plated metal shell with mounted Bakelite knob.  
 Range 0 to 700,000 Ohms.  
 Stock No. 2120.....\$1.25 list  
 Range 0 to 500,000 Ohms.  
 Stock No. 2130.....\$1.25 list



**Interference and Static Eliminator**  
 Mounted Bakelite shell with metal case adjusting screw.  
 Stock No. 1800.....\$2.50 list



**Variable Condensers**  
 Mounted Bakelite case.  
 Bakelite construction 500000 pF.  
 Stock No. 1700.....\$1.00 list  
 Variable gold contact 500000 pF.  
 Stock No. 1750.....\$1.00 list



**Fixed Condensers**  
 Highly polished metal and glass with adjustable softening legs. Bakelite plate-metal terminals—Brite Vitebron—gives maximum capacity.  
 Used by leading set builders.  
 All popular sizes—from 50 to 850 pF.

**Knife Throw Switches**

Mixed Bakelite base—Spring brass contact—Bakelite insulating handle.



Single Pole, Double Throw  
 Base 2 1/4" x 1 1/2"  
 Stock No. 2010.....\$1.00 list



Double Pole, Double Throw  
 Base 2 1/4" x 1 1/2"  
 Stock No. 2020.....\$1.00 list

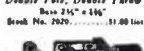

Triple Pole, Double Throw  
 Base 2 1/4" x 2"  
 Stock No. 2030.....\$1.50 list

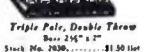

Four Pole, Double Throw  
 Base 2 1/4" x 2 1/4"  
 Stock No. 2040.....\$2.50 list



**Antenna Plug**  
 Black machined Bakelite. 2 1/4" long.  
 Stock No. 2050.....60c list



**Resistance Amplifiers**  
 Complete wired ready for installation. Individually packed with instructions.  
 Stock No. 1410 (2 stages).....\$6.00 list  
 Stock No. 1400 (3 stages).....\$10.00 list



**Standard Complete Aerial Kit**  
 Contains all necessary parts to erect. Arranged in individual sections.  
 Stock No. 210.....\$3.50 list

## Sheet Copper for Shielding

### Shielding

*Prevents* aerial radiation and feedback.

*Insulates* against interference from adjoining circuits.

*Improves* efficiency, selectivity and tone quality.

USE SHEET COPPER because it combines low resistance with easy working qualities.

**COPPER & BRASS RESEARCH ASSOCIATION**  
 25 Broadway — New York



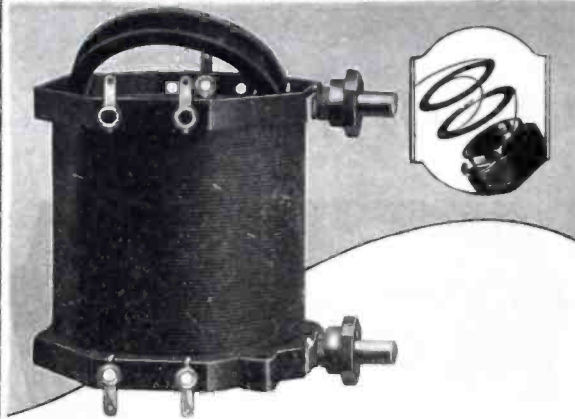

## A Universal, Supremely Efficient Coil for short or long wave lengths

Whether you want complete coils for high or low frequency (short or long wave length) work—

or  
wish quick changes per plug-in method—

or  
want to mount a coil in any position—

or  
if you desire one or two rotors you will find a standard Samson Form or Complete Coil for your purpose.

The Samson Electric Company has ready for delivery for those who desire to wind their own:

Coil Form, bare.....	\$ .75
Jack Block .....	\$1.00
Single Rotor Coupler, bare.....	\$1.25
Double Rotor Coupler, bare.....	\$2.00

And for those who wish complete units:	
Band Filter .....	\$7.50
Fixed Coupler .....	\$2.00
Split Stator Coupler.....	\$3.50
Single Rotor Coupler.....	\$3.25
Double Rotor Coupler.....	\$5.00
Antenna Coil .....	\$1.85
Double Wound Coupler.....	\$2.50

Our book — "Audio Amplification" — already accepted as a manual of audio design by many radio engineers—contains much original information of greatest practical value to those interested in bettering the quality of their reproduction. Sent upon receipt of 25 cents.

**SAMSON ELECTRIC COMPANY**  
Manufacturers Since 1882

Sales Offices in  
Thirty Leading Cities

**RMA**

Main Offices at  
Canton, Mass.  
Factories:  
Canton and Watertown

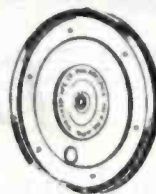

A complete metallic shield forms the back of the Eby Dial and minimizes the effect of body capacity. Removing hand does not detune receiver.

# New!

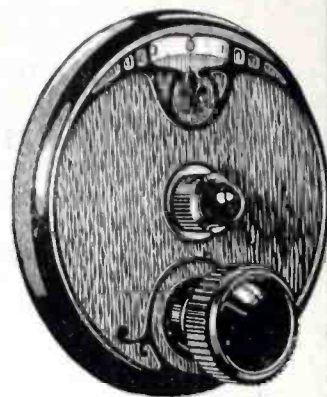

## The **EBY** SHIELDED DIAL

Even the best instruments are inefficient unless properly controlled and accurately set. This sensitive, finely constructed dial is scientifically designed for exact micrometer tuning.

Hairline accuracy is obtained by smooth positive friction drive, eliminating all backlash.

The Eby Shielded Dial operates any type condenser. Easy to mount by drilling one additional hole.

List Price \$2.50



## EBY SOCKETS

The Eby Socket assures a positive three-point wiping contact at all times. When the tube moves, the patented construction actually makes the contact tighter and checks the jar.

List Price 50 cents

**THE H. H. EB Y MFG. CO.,**  
4710 Stenton Ave., Philadelphia, Pa.

Makers of Eby Binding Posts





## Increase the Volume of Your Present Set

It is easy now to get much greater undistorted power from your present radio receiver whether it has 2 tubes or 8 tubes. At the same time and at little additional expense you eliminate the need of B-Batteries.

Power amplified many times with no sacrifice in tone quality. Distant stations that you have difficulty getting on the loud speaker now, will

come in strong and clear. And your B-Power supply is consistent, smooth and reliable at all times.

Your opportunities for good programs are expanded instantly to include practically everything you want. Modernize your present set—the cost is small and installation very simple.

### No. 3527 Unit Full Wave Rectifier

for use with one UX 213 tube and power amplifier UX No. 171 tube. This unit includes one No. 2505 transformer and two No. 514 chokes. Full Power and B-Battery Eliminator.

No. 3527—\$15.00 List



### No. 3523 Unit Half-Wave Rectifier

for use with One UX 216-B tube and power amplifier UX No. 210 tube. This unit includes one No. 2567 transformer and two No. 506 chokes built into durable metal case. Amplifies power a plenty for home use. Also eliminates B-Batteries.

No. 3523 Unit—\$17.50 List

### No. 3516 Full Wave Rectifier

for use with one Raytheon BH tube and one UX No. 171 tube. This unit includes one No. 2593 transformer and two No. 514 chokes built into substantial metal case. Exceptional power for all purposes. Eliminates B-Batteries.

No. 3516—\$13.00 List

*Send check or money order to factory if your dealer cannot supply you. Deliveries are prompt.*

#### MANUFACTURERS

As exclusive parts manufacturers Dongan offers the receiver and battery eliminator manufacturer a reliable source of supply. Our engineering dept will co-operate with you in effecting the proper designs of the latest types for your requirements. Ask for a representative or send your specifications.

**DONGAN ELECTRIC MANUFACTURING COMPANY**  
2995-3001 Franklin St.,  
DETROIT, MICHIGAN

**TRANSFORMERS of MERIT for FIFTEEN YEARS**



# AMERTRAN RADIO PRODUCTS

Sold Only by  
Authorized AmerTran  
Dealers

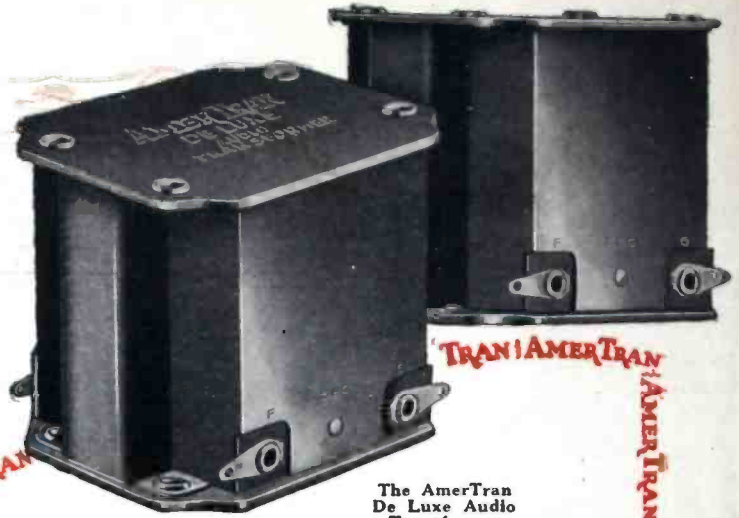

The AmerTran  
De Luxe Audio  
Transformer  
Sets a new Standard  
of excellence in  
Audio Amplification  
Made for 2 Stages  
\$10.00 Each



The AmerTran  
Power Transformer  
Type PF-52

Type PF-52 is intended for use in the better type of power supply developments. It will convert the standard 110-volt, 60-cycle alternating house-lighting current to a higher voltage for the plate, and lower voltage for filament supply.

Price \$18.00 Each



The AmerChoke  
Type 854

This is a scientifically designed impedance or choke coil of general utility, designed primarily for use in filter circuits. As an output impedance for by-passing direct current from the loud speaker it is both efficient and economical.

Price \$6.00 Each



AmerTran Types AF-7  
and AF-6

AmerTran Audio Transformers, types AF-7 and AF-6, have been considered for years among the leaders in audio amplification. These popular and efficient models are made in two types—AF-7 (ratio 3½:1)—AF-6 (ratio 5:1).  
\$5.00 Each

## For Satisfaction— Buy These Dependable Parts

Audio transformers and power supply units are today the largest selling groups of parts. The American Transformer Company manufactures both. Experience, plus the willingness to make only products that measure up to laboratory standards are responsible for the high efficiency of AmerTran products.

Such parts are worth buying. They out-perform and out-last units less skillfully designed and made. They mean permanent satisfaction. You are not saving money on cheaper radio parts which break, wear out, and even when new cannot come up to the AmerTran standard.

Keep these facts in mind when buying for replacement, for a new circuit or power supply equipment. You will get most value and most enjoyment if your dollars are spent for dependable AmerTran products.

Write for free booklet "Improving the Audio Amplifier." It contains valuable technical data.

**AMERICAN TRANSFORMER COMPANY**

178 Emmet St., Newark, N. J.

"Transformer Builders for over Twenty-six Years."